



Flex 12EX-A/B System

Radio Control Equipment

Instruction Manual



MAGNETEK
MATERIAL HANDLING
ENRANGE

0-FLEX-12EXABME R3
December 2012
© Copyright 2012 Magnetek Material Handling

Service Information

Your New Radio System

Thank you for your purchase of Magnetek's Enrange™ Flex EX radio remote control system. Without a doubt, our Flex EX system is the ultimate solution for providing precise, undeterred, and safe control of your material.

If your product ever needs modification or service, please contact one of our representatives at the following locations:

U.S. Service Information

For questions regarding service or technical information contact:

1.866.MAG.SERV

1.866.624.7378

World Headquarters:

Magnetek, Inc.
N49 W13650 Campbell Drive
Menomonee Falls, WI 53051

Telephone: 1.800.288.8178

Website: www.magnetekmh.com

e-mail: info@magnetekmh.com

Fax Numbers:

Main: 1.800.298.3503

Sales: 1.262.783.3510

Service: 1.262.783.3508

Magnetek, Inc. has additional satellite locations for Canada and the United States. For more information, please visit <http://www.magnetekmh.com>.

©2012 MAGNETEK

All rights reserved. This notice applies to all copyrighted materials included with this product, including, but not limited to, this manual and software embodied within the product. This manual is intended for the sole use of the person(s) to whom it was provided, and any unauthorized distribution of the manual or dispersal of its contents is strictly forbidden. This manual may not be reproduced in whole or in part by any means whatsoever without the expressed written permission of MAGNETEK.

PRODUCT MANUAL SAFETY INFORMATION

Magnetek, Inc. (Magnetek) offers a broad range of radio remote control products, control products and adjustable frequency drives, and industrial braking systems for material handling applications. This manual has been prepared by Magnetek to provide information and recommendations for the installation, use, operation and service of Magnetek's material handling products and systems (Magnetek Products). Anyone who uses, operates, maintains, services, installs or owns Magnetek Products should know, understand and follow the instructions and safety recommendations in this manual for Magnetek Products.

The recommendations in this manual do not take precedence over any of the following requirements relating to cranes, hoists lifting devices or other material handling equipment which use or include Magnetek Products:

- Instructions, manuals, and safety warnings of the manufacturers of the equipment where the radio system is used,
- Plant safety rules and procedures of the employers and the owners of facilities where the Magnetek Products are being used,
- Regulations issued by the Occupational Health and Safety Administration (OSHA),
- Applicable local, state or federal codes, ordinances, standards and requirements, or
- Safety standards and practices for the industries in which Magnetek Products are used.

This manual does not include or address the specific instructions and safety warnings of these manufacturers or any of the other requirements listed above. It is the responsibility of the owners, users and operators of the Magnetek Products to know, understand and follow all of these requirements. It is the responsibility of the employer to make its employees aware of all of the above listed requirements and to make certain that all operators are properly trained. **No one should use Magnetek Products prior to becoming familiar with and being trained in these requirements and the instructions and safety recommendations in this manual.**

WARRANTY INFORMATION

For information on Magnetek's product warranties by product type, please visit www.magnetekmh.com.

Table of Contents

1. INTRODUCTION.....	6
2. RADIO CONTROLLED SAFETY	7
2.1 CRITICAL INSTALLATION CONSIDERATIONS.....	8
2.2 GENERAL	8
2.3 PERSONS AUTHORIZED TO OPERATE RADIO CONTROLLED CRANES.....	8
2.4 SAFETY INFORMATION AND RECOMMENDED TRAINING FOR RADIO CONTROLLED EQUIPMENT OPERATORS	9
2.5 TRANSMITTER UNIT.....	10
2.6 PRE-OPERATION TEST	10
2.7 BATTERIES.....	11
2.8 BATTERY HANDLING	11
2.9 BATTERY CHARGING.....	11
2.10 BATTERY DISPOSAL.....	11
2.11 SPECIFIC SYSTEM WARNINGS	12
3. GENERAL SYSTEM INFORMATION.....	13
3.1 TRANSMITTER HANDSET.....	13
3.1.1 External Illustration (Standard Push Button Configuration).....	13
3.1.2 Internal Illustration.....	14
3.2 RECEVIER UNIT	15
3.2.1 External Illustration	15
3.2.2 Internal Illustration.....	16
4. FUNCTION SETTINGS.....	17
4.1 TRANSMITTER HANDSET.....	17
4.1.1 System Channel Settings	17
4.1.2 Continuous Transmitting Time Adjustment.....	18
4.1.3 Push Button Functions with LED Displays	19
4.1.3.1 Standard Push Button Configuration (Transmitter Toggle).....	19
4.1.3.2 Standard Push Button Configuration (A/B Selector).....	20
4.1.3.3 Inline Push Button Configuration (Transmitter Toggle).....	22
4.1.3.4 Inline Push Button Configuration (A/B Selector).....	23
4.1.4 Channel Change via Push Buttons.....	26
4.1.5 Optional 4-Digit Security Code	27
4.1.6 I-CHIP	28
4.2 RECEIVER UNIT.....	29
4.2.1 System Channel Settings	29
4.2.2 Output Relay Configurations.....	30
4.2.2.1 Output Relay Types	30
4.2.2.2 Output Relay Actions at 2nd Speed	30
4.2.2.3 ON/OFF Push Button Function	31
4.2.2.4 START/AUX Function	31
4.2.2.5 Magnet ON/OFF Push Button Function	32
4.2.2.6 Brake Function	32
4.2.2.7 Momentary Contact.....	32
4.2.2.8 Toggled Contact.....	32
4.2.2.9 3rd Speed Push Button Function	32
4.2.2.10 Auxiliary STOP Push Button Function	32
4.2.2.11 Pitch & Catch Function.....	32
4.2.3 Receiver Auto-Scanning Settings	33
4.2.4 Dip-Switch Settings.....	34
4.2.4.1 Interlocked Functions	34
4.2.4.2 Non-Interlocked Functions	35
4.2.5 Jumper Settings	36
4.2.6 I-CHIP Programming Port.....	37
4.2.7 Voltage Settings.....	37

5. SYSTEM CHANNELS TABLE	38
6. RECEIVER INSTALLATION	39
6.1 OUTPUT RELAY CONTACT DIAGRAM.....	39
6.2 PRE-INSTALLATION PRECAUTIONS	40
6.3 STEP-BY-STEP INSTALLATION.....	40
6.4 SYSTEM TESTING	41
7. Operating Procedure.....	42
7.1 TRANSMITTER OPERATION.....	42
7.1.1 General Operating Procedure.....	42
7.1.2 Rotary Select A/B Operating Procedure.....	43
7.1.3 Push Button Select A/B Operating Procedure.....	43
7.1.4 3rd Speed Push Button Operating Procedure.....	44
7.1.5 Pitch & Catch Operating Procedure.....	44
7.1.6 Automatic Channel Scanning Operating Procedure.....	44
7.1.7 Changing Transmitter Batteries	45
7.2 STATUS LIGHT INDICATORS & WARNINGS	46
7.2.1 Transmitter STATUS Light Indication	46
7.2.2 Receiver STATUS Light Indication	47
7.2.3 Receiver SQ Light Indication	47
7.2.4 Receiver POWER Light Indication.....	47
7.2.5 Receiver COM Light Indication	47
7.3 TROUBLESHOOTING TIPS	48
8. SYSTEM SPECIFICATIONS	49

1. INTRODUCTION

The Flex radio remote control systems are designed for control of industrial equipment and machinery such as overhead traveling cranes, jib cranes, gantry cranes, tower cranes, electric hoists, winches, monorails, conveyor belts, mining equipment and other material handling equipment where wireless control is preferred.

Each Flex system consists of a transmitter handset and receiver unit. Other standard-equipped accessories include transmitter waist belt, spare transmitter power key, clear vinyl pouch, "AA" alkaline batteries, compass direction decal sheet and user's manual.

List of notable features include:

- **62 user-programmable channels** – Advanced synthesized RF controls with 62 built-in channels; there are no more fixed channels and fragile quartz crystals to break.
- **Automatic channel scanning receiver** – No more hassle of climbing up the crane to change receiver channels.
- **Over one million unique ID codes (20bit)** – Each and every Flex system has its own unique ID codes and serial number; never repeats.
- **Advanced controls** – The Flex system utilizes advanced microprocessor controls with 32bit CRC and Hamming Code, which provide ultra-fast, safe, precise, and error-free encoding and decoding.
- **Unique I-CHIP design** – The I-CHIP functions in a way that is very similar to SIM cards used on mobile phones, with the ability to transfer system information and settings from one transmitter to another without the hassle of resetting the spares.
- **Reliable push buttons** – The in-house designed push buttons with gold-plated contacts are rated for more than one million press cycles.
- **Low power consumption** – Requires only two "AA" Alkaline batteries for more than 100 hours of operating time between replacements.
- **Ultra-durable nylon and fiberglass composite enclosures** – Highly resistant to breakage and deformation even in the most abusive environments.
- **Full compliance** – All systems are fully compliant with the FCC Part-15 Rules, European Directives (Safety, EMC, R&TTE, Machinery), and Industry Canada Specifications (IC).

2. RADIO CONTROLLED SAFETY

WARNINGS and CAUTIONS

Throughout this document WARNING and CAUTION statements have been deliberately placed to highlight items critical to the protection of personnel and equipment.

WARNING – A warning highlights an essential operating or maintenance procedure, practice, etc. which if not strictly observed, could result in injury or death of personnel, or long term physical hazards. Warnings are highlighted as shown below:



CAUTION – A caution highlights an essential operating or maintenance procedure, practice, etc. which if not strictly observed, could result in damage to, or destruction of equipment, or loss of functional effectiveness. Cautions are highlighted as shown below:



WARNINGS and CAUTIONS SHOULD NEVER BE DISREGARDED.

The safety rules in this section are not intended to replace any rules or regulations of any applicable local, state, or federal governing organizations. Always follow your local lockout and tagout procedure when maintaining any radio equipment. The following information is intended to be used in conjunction with other rules or regulations already in existence. It is important to read all of the safety information contained in this section before installing or operating the Radio Control System.

2.1 CRITICAL INSTALLATION CONSIDERATIONS



PRIOR TO INSTALLATION AND OPERATION OF THIS EQUIPMENT, READ AND DEVELOP AN UNDERSTANDING OF THE CONTENTS OF THIS MANUAL AND THE OPERATION MANUAL OF THE EQUIPMENT OR DEVICE TO WHICH THIS EQUIPMENT WILL BE INTERFACED. FAILURE TO FOLLOW THIS WARNING COULD RESULT IN SERIOUS INJURY OR DEATH AND DAMAGE TO EQUIPMENT.

ALL EQUIPMENT MUST HAVE A MAINLINE CONTACTOR INSTALLED AND ALL TRACKED CRANES, HOISTS, LIFTING DEVICES AND SIMILAR EQUIPMENT MUST HAVE A BRAKE INSTALLED. FAILURE TO FOLLOW THIS WARNING COULD RESULT IN SERIOUS INJURY OR DEATH AND DAMAGE TO EQUIPMENT.

AN AUDIBLE AND/OR VISUAL WARNING MEANS MUST BE PROVIDED ON ALL REMOTE CONTROLLED EQUIPMENT AS REQUIRED BY CODE, REGULATION, OR INDUSTRY STANDARD. THESE AUDIBLE AND/OR VISUAL WARNING DEVICES MUST MEET ALL GOVERNMENTAL REQUIREMENTS. FAILURE TO FOLLOW THIS WARNING COULD RESULT IN SERIOUS INJURY OR DEATH AND DAMAGE TO EQUIPMENT.

FOLLOW YOUR LOCAL LOCKOUT TAGOUT PROCEDURE BEFORE MAINTAINING ANY REMOTE CONTROLLED EQUIPMENT. ALWAYS REMOVE ALL ELECTRICAL POWER FROM THE CRANE, HOIST, LIFTING DEVICE OR SIMILAR EQUIPMENT BEFORE ATTEMPTING ANY INSTALLATION PROCEDURES. DE-ENERGIZE AND TAGOUT ALL SOURCES OF ELECTRICAL POWER BEFORE TOUCH-TESTING ANY EQUIPMENT. FAILURE TO FOLLOW THIS WARNING COULD RESULT IN SERIOUS INJURY OR DEATH AND DAMAGE TO EQUIPMENT.

THE DIRECT OUTPUTS OF THIS PRODUCT ARE NOT DESIGNED TO INTERFACE DIRECTLY TO TWO STATE SAFETY CRITICAL MAINTAINED FUNCTIONS, I.E., MAGNETS, VACUUM LIFTS, PUMPS, EMERGENCY EQUIPMENT, ETC. A MECHANICALLY LOCKING INTERMEDIATE RELAY SYSTEM WITH SEPARATE POWER CONSIDERATIONS MUST BE PROVIDED. FAILURE TO FOLLOW THIS WARNING COULD RESULT IN SERIOUS INJURY OR DEATH OR DAMAGE TO EQUIPMENT.

2.2 GENERAL

Radio controlled material handling equipment operates in several directions. Cranes, hoists, lifting devices and other material handling equipment can be large, and operate at high speeds. Quite frequently, the equipment is operated in areas where people are working in close proximity to the material handling equipment. **The operator must exercise extreme caution at all times.** Workers must constantly be alert to avoid accidents. The following recommendations have been included to indicate how careful and thoughtful actions may prevent injuries, damage to equipment, or even save a life.

2.3 PERSONS AUTHORIZED TO OPERATE RADIO CONTROLLED CRANES

Only properly trained persons designated by management should be permitted to operate radio controlled equipment.

Radio controlled cranes, hoists, lifting devices and other material handling equipment should not be operated by any person who cannot read or understand signs, notices and operating instructions that pertain to the equipment.

Radio controlled equipment should not be operated by any person with insufficient eyesight or hearing or by any person who may be suffering from a disorder or illness, is taking any medication that may cause loss of equipment control, or is under the influence of alcohol or drugs.

2.4 SAFETY INFORMATION AND RECOMMENDED TRAINING FOR RADIO CONTROLLED EQUIPMENT OPERATORS

Anyone being trained to operate radio controlled equipment should possess as a minimum the following knowledge and skills before using the radio controlled equipment.

The operator should:

- have knowledge of hazards pertaining to equipment operation
- have knowledge of safety rules for radio controlled equipment
- have the ability to judge distance of moving objects
- know how to properly test prior to operation
- be trained in the safe operation of the radio transmitter as it pertains to the crane, hoist, lifting device or other material handling equipment being operated
- have knowledge of the use of equipment warning lights and alarms
- have knowledge of the proper storage space for a radio control transmitter when not in use
- be trained in transferring a radio control transmitter to another person
- be trained how and when to report unsafe or unusual operating conditions
- test the transmitter emergency stop and all warning devices prior to operation; testing should be done on each shift, without a load
- be thoroughly trained and knowledgeable in proper and safe operation of the crane, hoist, lifting device, or other material handling equipment that utilizes the radio control
- know how to keep the operator and other people clear of lifted loads and to avoid “pinch” points
- continuously watch and monitor status of lifted loads
- know and follow cable and hook inspection procedures
- know and follow the local lockout and tagout procedures when servicing radio controlled equipment
- know and follow all applicable operating and maintenance manuals, safety procedures, regulatory requirements, and industry standards and codes

The operator shall not:

- lift or move more than the rated load
- operate the material handling equipment if the direction of travel or function engaged does not agree with what is indicated on the controller
- use the crane, hoist or lifting device to lift, support or transport people
- lift or carry any loads over people
- operate the crane, hoist or lifting device unless all persons, including the operator, are and remain clear of the supported load and any potential pinch points
- operate a crane, hoist or lifting device when the device is not centered over the load
- operate a crane, hoist or lifting device if the chain or wire rope is not seated properly in the sprockets, drum or sheave

- operate any damaged or malfunctioning crane, hoist, lifting device or other material handling equipment
- change any settings or controls without authorization and proper training
- remove or obscure any warning or safety labels or tags
- leave any load unattended while lifted
- leave power on the radio controlled equipment when the equipment is not in operation
- operate any material handling equipment using a damaged controller because the unit may be unsafe
- operate manual motions with other than manual power
- operate radio controlled equipment when low battery indicator is on



WARNING

THE OPERATOR SHOULD NOT ATTEMPT TO REPAIR ANY RADIO CONTROLLER. IF ANY PRODUCT PERFORMANCE OR SAFETY CONCERNS ARE OBSERVED, THE EQUIPMENT SHOULD IMMEDIATELY BE TAKEN OUT OF SERVICE AND BE REPORTED TO THE SUPERVISOR. DAMAGED AND INOPERABLE RADIO CONTROLLER EQUIPMENT SHOULD BE RETURNED TO MAGNETEK FOR EVALUATION AND REPAIR. FAILURE TO FOLLOW THIS WARNING COULD RESULT IN SERIOUS INJURY OR DEATH AND DAMAGE TO EQUIPMENT.

2.5 TRANSMITTER UNIT

Transmitter switches should never be mechanically blocked ON or OFF. When not in use, the operator should turn the transmitter OFF. A secure storage space should be provided for the transmitter unit, and the transmitter unit should always be placed there when not in use. This precaution will help prevent unauthorized people from operating the material handling equipment.

Spare transmitters should be stored in a secure storage space and only removed from the storage space after the current transmitter in use has been turned OFF, taken out of the service area and secured.

2.6 PRE-OPERATION TEST

At the start of each work shift, or when a new operator takes control of the crane, operators should do, as a minimum, the following steps before making lifts with any crane or hoist:

Test all warning devices.

Test all direction and speed controls.

Test the transmitter emergency stop.

2.7 BATTERIES



WARNING

KNOW AND FOLLOW PROPER BATTERY HANDLING, CHARGING AND DISPOSAL PROCEDURES. IMPROPER BATTERY PROCEDURES CAN CAUSE BATTERIES TO EXPLODE OR DO OTHER SERIOUS DAMAGE. FAILURE TO FOLLOW THIS WARNING COULD RESULT IN SERIOUS INJURY OR DEATH AND DAMAGE TO EQUIPMENT.

2.8 BATTERY HANDLING

Use only batteries approved by Magnetek for the specific product.

Do not dispose of a battery pack in fire; it may explode.

Do not attempt to open the battery pack.

Do not short circuit the battery.

For intrinsically safe environments only use specified Magnetek Telemotive intrinsically safe batteries.

Keep the battery pack environment cool during charging operation and storage (i.e., not in direct sunlight or close to a heating source).

2.9 BATTERY CHARGING

For those transmitters equipped with battery chargers, please familiarize all users with the instructions of the charger before attempting to use.

Do not attempt to charge non-rechargeable battery packs.

Avoid charging partially discharged rechargeable batteries to help prolong battery cycle life.

Avoid charging the battery pack for more than 24 hours at a time.

Do not charge batteries in a hazardous environment.

Do not short the charger.

Do not attempt to charge a damaged battery.

Use only Magnetek Telemotive approved chargers for the appropriate battery pack.

Do not attempt to use a battery that is leaking, swollen or corroded.

Charger units are not intended for outdoor use. Use only indoors.

2.10 BATTERY DISPOSAL

Before disposing of batteries consult local and governmental regulatory requirements for proper disposal procedure.

2.11 SPECIFIC SYSTEM WARNINGS

Below are some specific operating safety tips that should be strictly followed when operating a Flex 12EX-A/B System:

1. Check the Status LED on the transmitter for any signs of low battery power (refer to page 46).
2. Check the Status LED on the transmitter for any signs of irregularities (refer to page 46).
3. Make sure the system is not set to the same channel as any other Flex systems in use within a distance of 300 meters (900 feet).
4. Never operate a crane or equipment with two transmitter handsets at the same time unless they are programmed with the "Pitch & Catch" function. For information on the "Pitch & Catch" feature, please refer to page 32 and page 44 of this manual.

3. GENERAL SYSTEM INFORMATION

3.1 TRANSMITTER HANDSET

3.1.1 External Illustration (Standard Push Button Configuration)

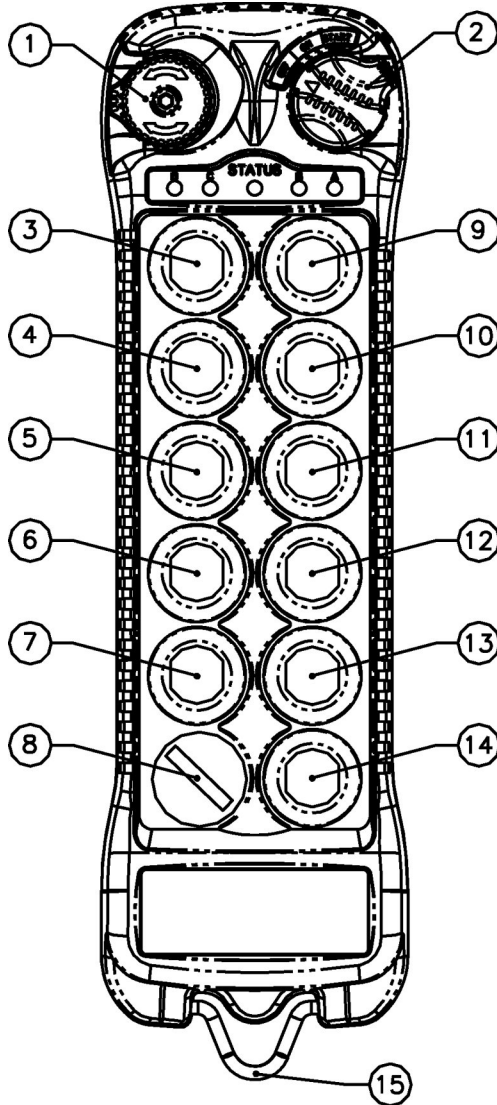

(Fig. 01)

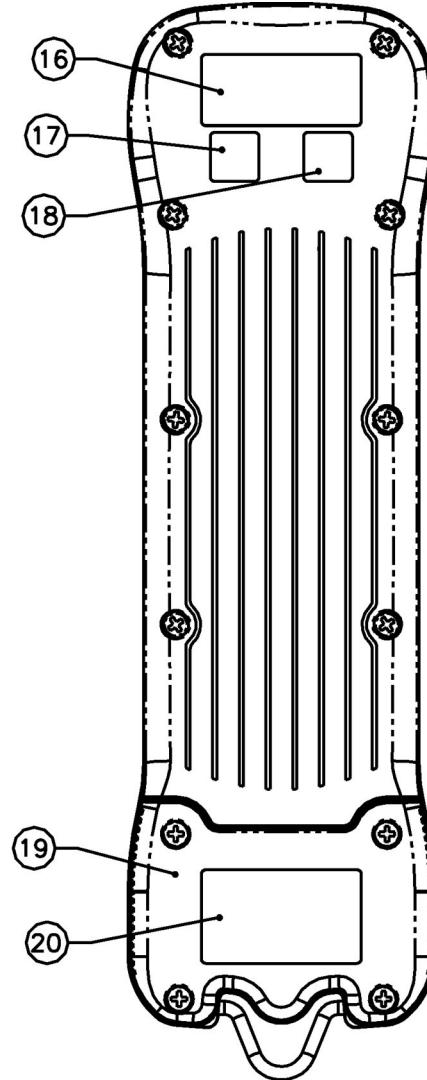

(Fig. 02)

- 1. Emergency Stop Button
- 2. Removable Power Key Switch
- 3. Push Button #2
- 4. Push Button #4
- 5. Push Button #6
- 6. Push Button #8
- 7. Push Button #10

- 8. Select A/B/A+B switch
- 9. Push Button #1
- 10. Push Button #3
- 11. Push Button #5
- 12. Push Button #7
- 13. Push Button #9
- 14. Push Button #11

- 15. Strap Ring
- 16. System Information
- 17. System Channel
- 18. Crane Number
- 19. Battery Cover
- 20. Approval Info

3.1.2 Internal Illustration

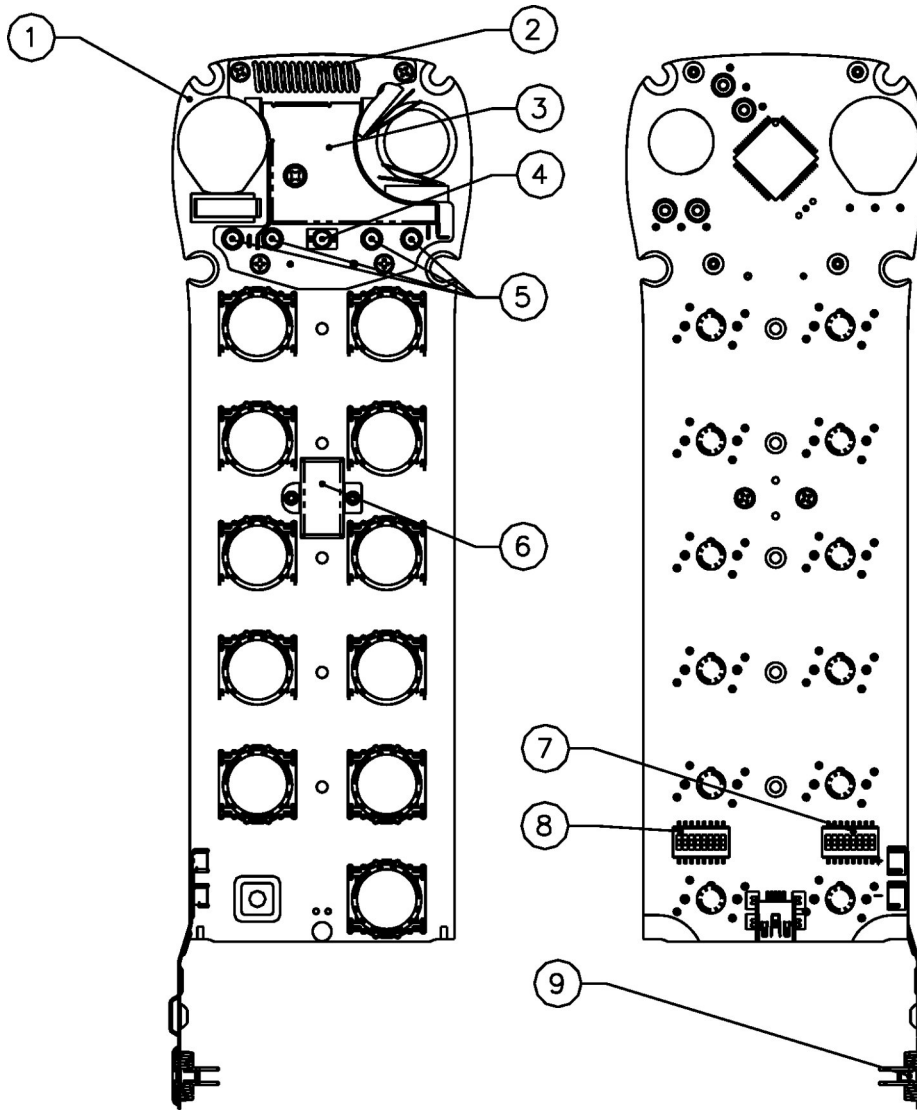

(Fig. 03)

- 1. Encoder Board
- 2. Arial Antenna
- 3. Transmitting Module
- 4. Status LED Display
- 5. Function LED Displays

(Fig. 04)

- 6. I-CHIP
- 7. Function Dip-Switch
- 8. Channel Dip-Switch
- 9. Battery Contact Mechanism

3.2 RECEVIER UNIT

3.2.1 External Illustration

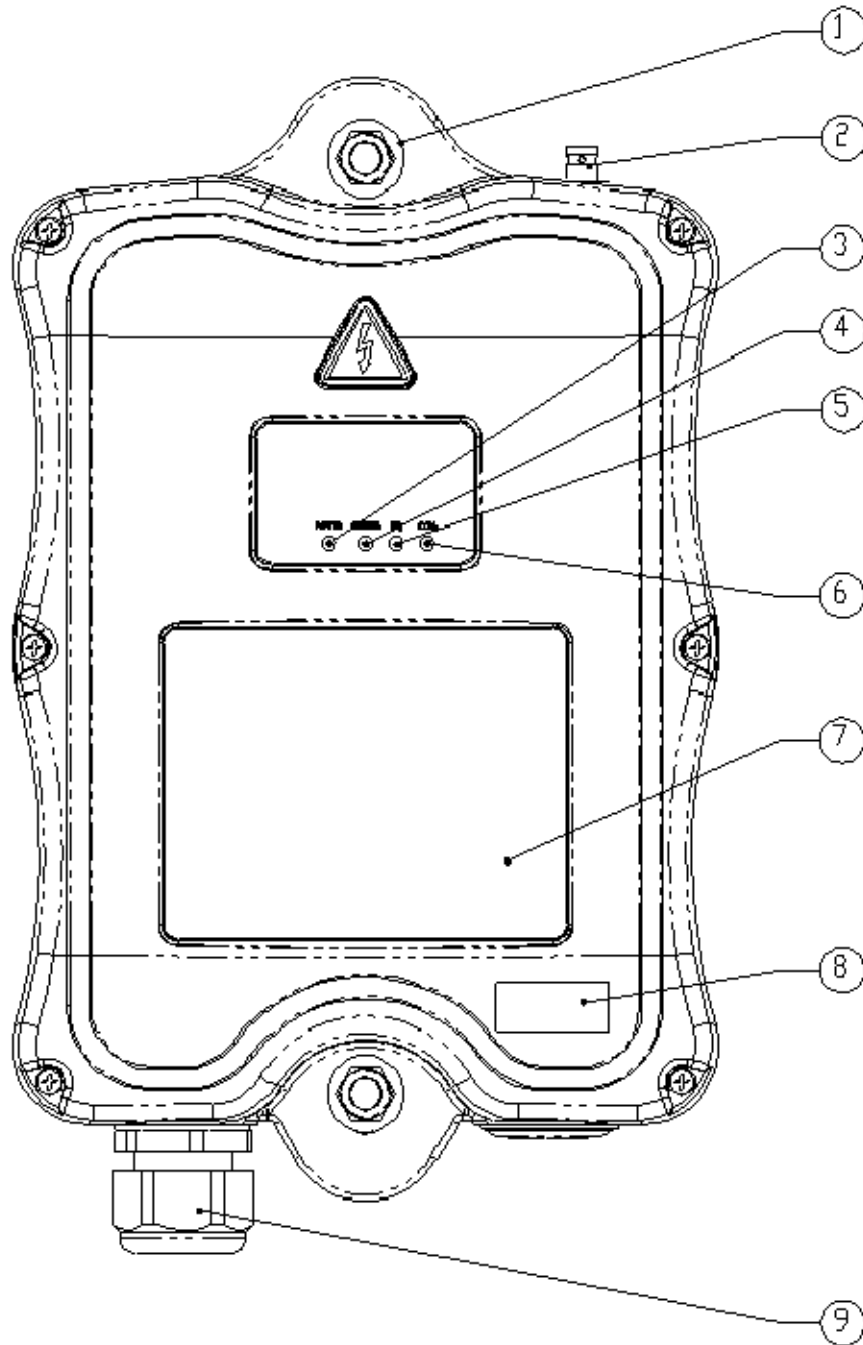

(Fig. 05)

- | | | | |
|----|-----------------------|----|------------------------|
| 1. | Shock Mount | 6. | COM LED Display |
| 2. | External Antenna Jack | 7. | Output Contact Diagram |
| 3. | Power LED Display | 8. | System Information |
| 4. | Status LED Display | 9. | Cord Grip |
| 5. | SQ LED Display | | |

3.2.2 Internal Illustration

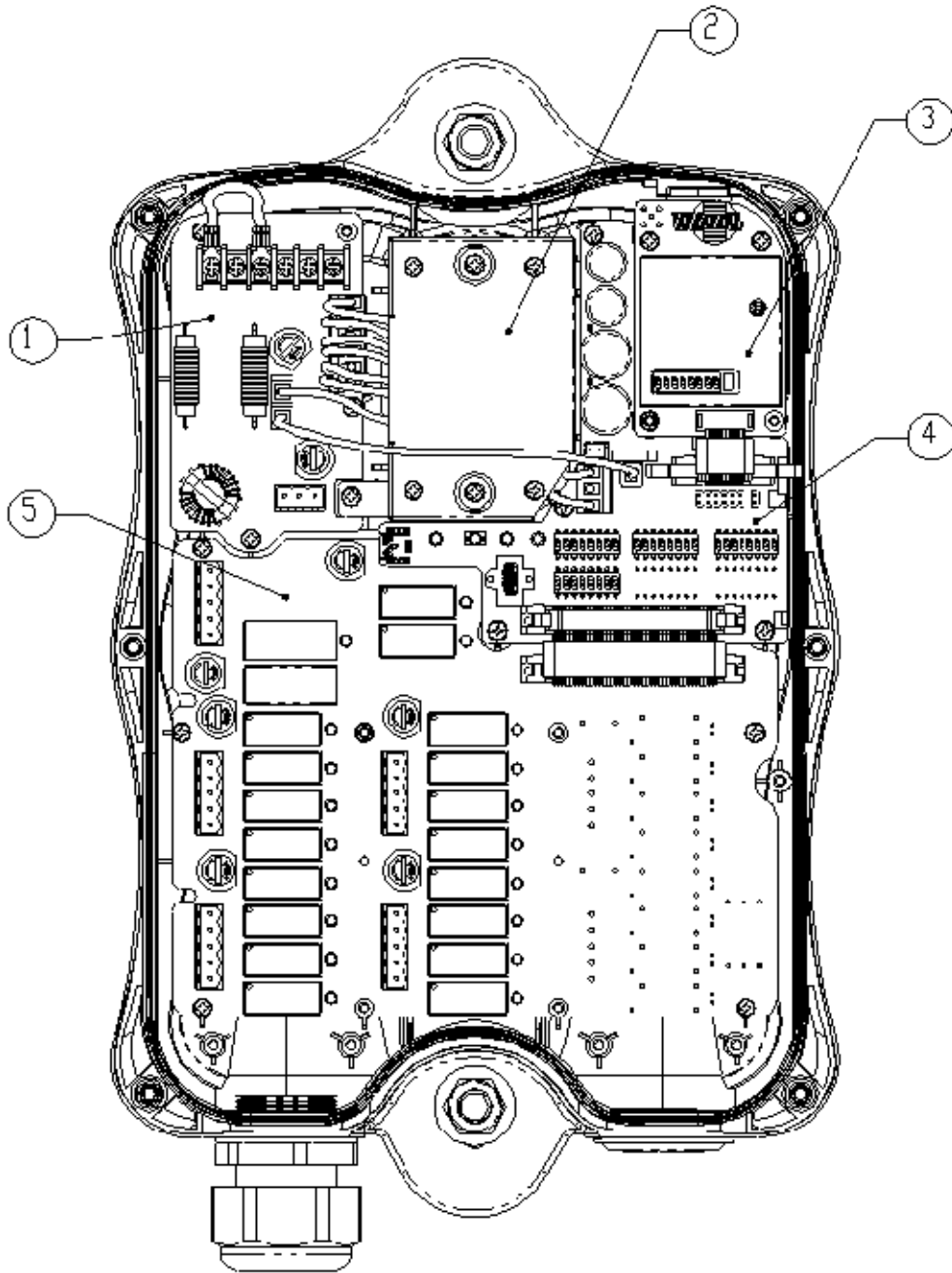

(Fig. 06)

- | | | | |
|----|-------------------|----|--------------------|
| 1. | AC Line Filter | 4. | Decoder Module |
| 2. | Power Transformer | 5. | Output Relay Board |
| 3. | Receiving Module | | |

4. FUNCTION SETTINGS

4.1 TRANSMITTER HANDSET

4.1.1 System Channel Settings

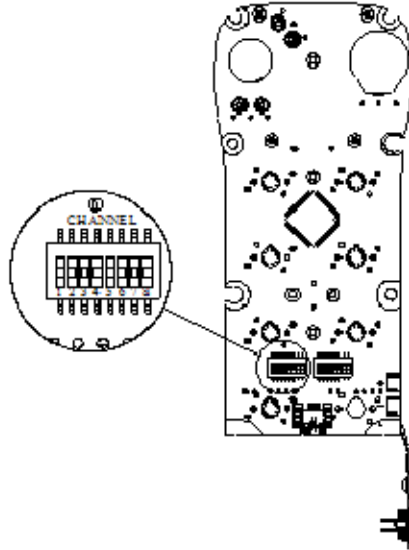

(Fig. 07)

Set the transmitter channel by adjusting the channel dip-switch located on the backside of the transmitter encoder board (refer to Fig. 07 above). Only the first six (6) positions are used for channel programming (refer to Fig. 08 below). The system channels table located on page 38 illustrates which dip-switch setting corresponds to which channel. Once the transmitter channel is altered, make sure to change the receiver channel as well. The channel on both the transmitter and receiver must be identical in order for the system to work. To change the receiver channel please refer to page 29.

Example:

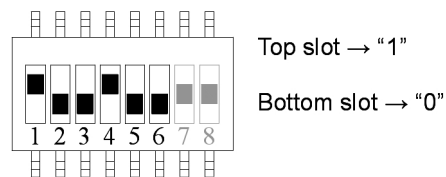

(Fig. 08)

The above dip-switch setting “1 0 0 1 0 0” corresponds to “channel 36” in the system channels table on page 38.

4.1.2 Continuous Transmitting Time Adjustment

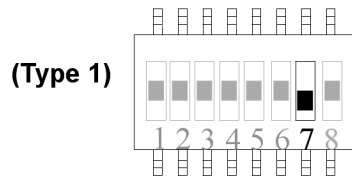

After the push button is released the transmitter will continue to transmit neutral signals to the receiver for up to one (1) minute. After one (1) minute the transmitter will cease transmission thus temporarily disconnecting the receiver MAIN.

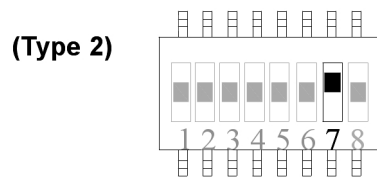

After the push button is released the transmitter will continue to transmit neutral signals to the receiver for up to three (3) minutes. After three (3) minutes the transmitter will cease transmission thus temporarily disconnecting the receiver MAIN. Please contact your local dealer if your application requires transmitting on time other than the pre-set value above.

4.1.3 Push Button Functions with LED Displays

4.1.3.1 Standard Push Button Configuration (Transmitter Toggle)

Set the transmitter toggle (latching output relay) function by adjusting the 8-position function dip-switch located on the backside of the transmitter encoder board (refer to Fig. 09 below). The LED 1 through LED 4 shown inside the shaded box (see below) illustrates which LED on the transmitter will light up when the designated push button (PB7 - PB11) is pressed.

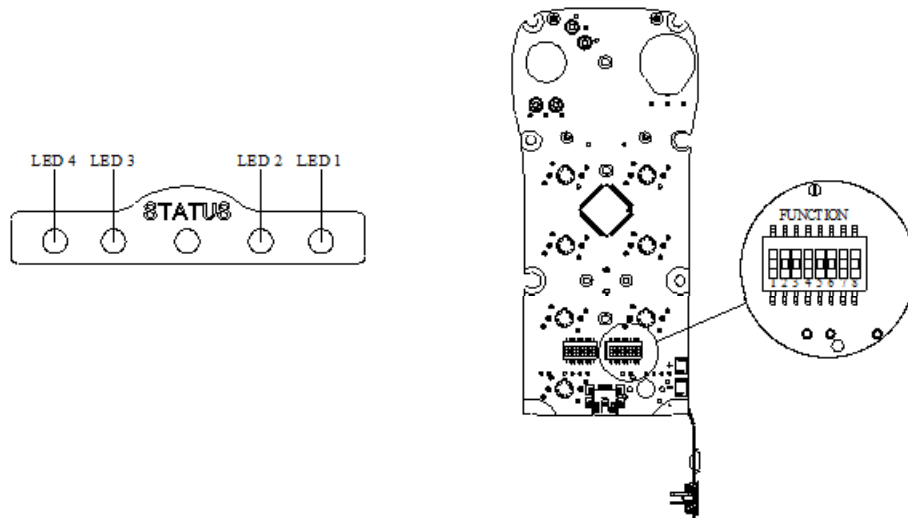

(Fig. 09)

	DIP	PB7	PB8	PB9	PB10	PB11
1	00000000	Normal	Normal	Normal	Normal	Normal
2	00001001	Normal	Normal	Normal	LED 4	Normal
3	00001010	Normal	Normal	LED 3	LED 4	Normal
4	00001011	Normal	LED 2	LED 3	LED 4	Normal
5	00001100	LED 1	LED 2	LED 3	LED 4	Normal
6	00001101	Normal	Normal	Normal	Normal	Normal
7	00001110	Normal	Normal	Normal	Normal	LED 3
8	00001111	Normal	Normal	Normal	LED 2	LED 3
9	00010000	Normal	Normal	LED 1	LED 2	LED 3

* PB7...PB11 → Push button number

* Normal → Normal momentary contact

* LED 1...LED 4 → Transmitter toggled with designated LED Display

4.1.3.2 Standard Push Button Configuration (A/B Selector)

There are four (4) different types of A/B selector sequences available on the Flex system. Choose the one that is most suitable for your application.

Type-A selector sequence : A+B → A → B → A+B ...
 Type-B selector sequence : Off → A → B → Off → A → B ...
 Type-C selector sequence : A → B → A+B → A → B → A+B ...
 Type-D selector sequence : Off → A → B → A+B → Off → A → B → A+B ...

	DIP	PB7	PB8	PB9	PB10	PB11
10	00101111	A/1&2	Normal	Normal	Normal	Normal
11	00110000	B/1&2	Normal	Normal	Normal	Normal
12	00110001	C/1&2	Normal	Normal	Normal	Normal
13	00110010	D/1&2	Normal	Normal	Normal	Normal
14	00110011	Normal	A/3&4	Normal	Normal	Normal
15	00110100	Normal	B/3&4	Normal	Normal	Normal
16	00110101	Normal	C/3&4	Normal	Normal	Normal
17	00110110	Normal	D/3&4	Normal	Normal	Normal
18	00110111	A/1&2	A/3&4	Normal	Normal	Normal
19	00111000	A/1&2	B/3&4	Normal	Normal	Normal
20	00111001	A/1&2	C/3&4	Normal	Normal	Normal
21	00111010	A/1&2	D/3&4	Normal	Normal	Normal
22	00111011	B/1&2	B/3&4	Normal	Normal	Normal
23	00111100	B/1&2	C/3&4	Normal	Normal	Normal
24	00111101	B/1&2	D/3&4	Normal	Normal	Normal
25	00111110	C/1&2	C/3&4	Normal	Normal	Normal
26	00111111	C/1&2	D/3&4	Normal	Normal	Normal
27	01000000	D/1&2	D/3&4	Normal	Normal	Normal

* PB7...PB11 → Push button number

* Normal → Normal momentary contact

* A/1&2...D/3&4 → A/B Selector type with designated LED Display (LED 1&2 or LED 3&4)

	DIP	PB7	PB8	PB9	PB10	PB11
46	01010011	Normal	Normal	Normal	Normal	A/1&2
47	01010100	Normal	Normal	Normal	Normal	B/1&2
48	01010101	Normal	Normal	Normal	Normal	C/1&2
49	01010110	Normal	Normal	Normal	Normal	D/1&2
50	01010111	Normal	Normal	Normal	Normal	Normal
51	01011000	Normal	Normal	Normal	Normal	Normal
52	01011001	Normal	Normal	Normal	Normal	Normal
53	01011010	Normal	Normal	Normal	Normal	Normal
54	01011011	Normal	Normal	Normal	Normal	A/1&2
55	01011100	Normal	Normal	Normal	Normal	A/1&2
56	01011101	Normal	Normal	Normal	Normal	A/1&2
57	01011110	Normal	Normal	Normal	Normal	A/1&2
58	01011111	Normal	Normal	Normal	Normal	B/1&2
59	01100000	Normal	Normal	Normal	Normal	B/1&2
60	01100001	Normal	Normal	Normal	Normal	B/1&2
61	01100010	Normal	Normal	Normal	Normal	C/1&2
62	01100011	Normal	Normal	Normal	Normal	C/1&2
63	01100100	Normal	Normal	Normal	Normal	D/1&2

* PB7...PB11 → Push button number

* Normal → Normal momentary contact

* A/1&2...D/3&4 → A/B Selector type with designated LED Display (LED 1&2 or LED 3&4)

4.1.3.3 Inline Push Button Configuration (Transmitter Toggle)

The push button arrangement for inline push button setup starts from top to bottom and then from the right column to the left column (refer to Fig. 10 below). To set the inline push button configuration, please refer to JP4 and JP5 jumpers setting on page 36. With inline push button configurations, PB1 & PB2 still corresponds to output relay K1~K4, PB3 & PB4 corresponds to relay K5~K8, etc...

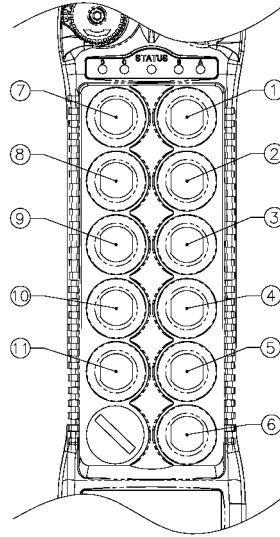

(Fig. 10)

	DIP	PB7	PB8	PB9	PB10	PB11
64	00000000	Normal	Normal	Normal	Normal	Normal
65	00000101	Normal	Normal	Normal	LED 4	Normal
66	00010100	Normal	Normal	LED 3	LED 4	Normal
67	00010101	Normal	LED 2	LED 3	LED 4	Normal
68	00010110	LED 1	LED 2	LED 3	LED 4	Normal
69	00001001	Normal	Normal	Normal	Normal	LED 4
70	00010111	Normal	Normal	Normal	LED 3	LED 4
71	00011000	Normal	Normal	LED 2	LED 3	LED 4
72	00011001	Normal	LED 1	LED 2	LED 3	LED 4
73	00001101	Normal	Normal	Normal	Normal	Normal
74	00011010	Normal	Normal	Normal	Normal	LED 3
75	00011011	Normal	Normal	Normal	LED 2	LED 3
76	00011100	Normal	Normal	LED 1	LED 2	LED 3

* PB7...PB11 → Push button number

* Normal → Normal momentary contact

* LED 1...LED 4 → Transmitter toggled with designated LED Display

4.1.3.4 Inline Push Button Configuration (A/B Selector)

There are four (4) different types of A/B selector sequences available on the Flex system. Choose the one that is most suitable for your application.

Type-A selector sequence : A+B → A → B → A+B ...
 Type-B selector sequence : Off → A → B → Off → A → B ...
 Type-C selector sequence : A → B → A+B → A → B → A+B ...
 Type-D selector sequence : Off → A → B → A+B → Off → A → B → A+B ...

	DIP	PB9	PB10	PB11
77	01110011	A/1&2	Normal	Normal
78	01110100	B/1&2	Normal	Normal
79	01110101	C/1&2	Normal	Normal
80	01110110	D/1&2	Normal	Normal
81	00110011	Normal	A/3&4	Normal
82	00110100	Normal	B/3&4	Normal
83	00110101	Normal	C/3&4	Normal
84	00110110	Normal	D/3&4	Normal
85	01110111	A/1&2	A/3&4	Normal
86	01111000	A/1&2	B/3&4	Normal
87	01111001	A/1&2	C/3&4	Normal
88	01111010	A/1&2	D/3&4	Normal
89	01111011	B/1&2	B/3&4	Normal
90	01111100	B/1&2	C/3&4	Normal
91	01111101	B/1&2	D/3&4	Normal
92	01111110	C/1&2	C/3&4	Normal
93	01111111	C/1&2	D/3&4	Normal
94	10000000	D/1&2	D/3&4	Normal

* PB7...PB11 → Push button number

* Normal → Normal momentary contact

* A/1&2...D/3&4 → A/B Selector type with designated LED Display (LED 1&2 or LED 3&4)

	DIP	PB9	PB10	PB11
95	10000001	Normal	A/1&2	Normal
96	10000010	Normal	B/1&2	Normal
97	10000011	Normal	C/1&2	Normal
98	10000100	Normal	D/1&2	Normal
99	01000101	Normal	Normal	A/3&4
100	01000110	Normal	Normal	B/3&4
101	01000111	Normal	Normal	C/3&4
102	01001000	Normal	Normal	D/3&4
103	10000101	Normal	A/1&2	A/3&4
104	10000110	Normal	A/1&2	B/3&4
105	10000111	Normal	A/1&2	C/3&4
106	10001000	Normal	A/1&2	D/3&4
107	10001001	Normal	B/1&2	B/3&4
108	10001010	Normal	B/1&2	C/3&4
109	10001011	Normal	B/1&2	D/3&4
110	10001100	Normal	C/1&2	C/3&4
111	10001101	Normal	C/1&2	D/3&4
112	10001110	Normal	D/1&2	D/3&4

* PB7...PB11 → Push button number

* Normal → Normal momentary contact

* A/1&2...D/3&4 → A/B Selector type with designated LED Display (LED 1&2 or LED 3&4)

	DIP	PB9	PB10	PB11
113	10001111	Normal	Normal	A/1&2
114	10010000	Normal	Normal	B/1&2
115	10010001	Normal	Normal	C/1&2
116	10010010	Normal	Normal	D/1&2
117	01010111	Normal	Normal	Normal
118	01011000	Normal	Normal	Normal
119	01011001	Normal	Normal	Normal
120	01011010	Normal	Normal	Normal
121	10010011	Normal	Normal	A/1&2
122	10010100	Normal	Normal	A/1&2
123	10010101	Normal	Normal	A/1&2
124	10010110	Normal	Normal	A/1&2
125	10010111	Normal	Normal	B/1&2
126	10011000	Normal	Normal	B/1&2
127	10011001	Normal	Normal	B/1&2
128	10011010	Normal	Normal	C/1&2
129	10011011	Normal	Normal	C/1&2
130	10011100	Normal	Normal	D/1&2

* PB7...PB11 → Push button number

* Normal → Normal momentary contact

* A/1&2...D/3&4 → A/B Selector type with designated LED Display (LED 1&2 or LED 3&4)

4.1.4 Channel Change via Push Buttons

Other than the CHANNEL dip-switch on the encoder board, the transmitter channel can also be changed directly on the push buttons. Please refer to the instructions below on how to change the transmitter channel via push buttons.

- a. Press and hold PB1, PB2 and PB3 and rotate the power key to START position at the same time. A series of green and red blinks will appear on the Status LED showing the current channel setting. A green blink represents the tens (+10) and a red blink represents the units (+1).

Examples: 2 green blinks followed by 5 red blinks represents channel 25.
 6 red blinks represents channel 06.

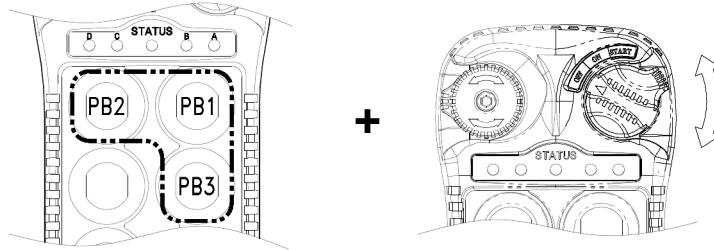

- b. Select a new channel by pressing PB1 and PB2 on the transmitter. Press PB1 to increment the units (+1) and PB2 to increment the tens (+10).

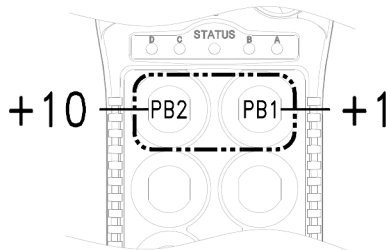

Examples: Pressing PB2 two times and then PB1 four times will give you channel 24.
 Pressing PB1 nine times will give you channel 09.

- c. When finished, the newly selected channel will appear on the Status LED via a series of green and red blinks again.
- d. Exit the channel programming by turning off the transmitter power.
- e. Make sure the receiver channel is set identical to the transmitter. Please refer to page 29 and page 33 on how to change the receiver channel.
- f. Please note that when the CHANNEL dip-switch inside the transmitter is changed, the priority will revert back to the new channel set on the CHANNEL dip-switch.
- g. Please note that when channel is set beyond channel 62 via PB1 and PB2 (i.e. channel 63, 68, 88, etc...), the system will recognize it as channel 62.

4.1.5 Optional 4-Digit Security Code

The 4-digit Security Code is an optional feature that can be programmed into the transmitter to allow operation only to those who know the code. If this feature is desired, set up as follows: Prior to rotating the transmitter power key-switch to START position to begin operation, you first enter a 4-digit security code in order to proceed further. When this 4-digit security code is entered correctly, a green light will appear on the Status LED. Please refer to the instruction below on how to program the 4-digit security code.

- a. Release E-Stop, press and hold PB1, PB2, PB3 and PB4 (all at once), and then rotate the power key to START position.

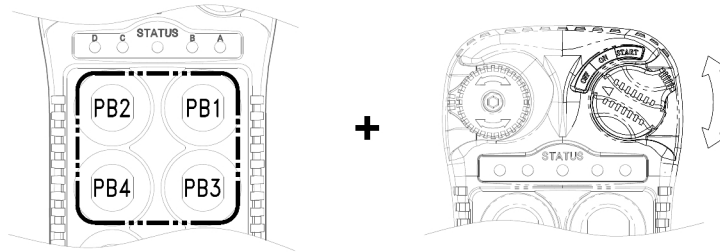

- b. A constant orange light will appear on the Status LED telling you that you are in the security code programming mode.
- c. For newly purchased system with the security code function deactivated (default setting), press PB1 four times (1111) to activate the security code function. At this time the Status LED on the transmitter will blink orange slowly telling you that the 4 digits entered is correct. Then select your own 4-digit security code by pressing PB1, PB2, PB3 or PB4 on the transmitter (four presses randomly). At this time, fast orange blinks are displayed on the Status LED telling you to reconfirm the 4-digit security code you have just entered. A green light will appear once you have re-entered the same 4-digit security code again (programming completed). If any mistake is made during this process, or if a red light is shown on the Status LED after you have re-entered the security code (incorrect input), or even if you believe you have entered the correct code but the transmitter fails to work properly, then you must reset the transmitter power (by power-cycling the transmitter*) and then repeat steps a, b and c again.

**NOTE: To power-cycle the transmitter, you must first remove, then reinstall the batteries. Simply turning the power switch off, then on will NOT properly clear the memory. This process must be used for any errors regarding proper transmitter operation (not just for security code settings).*

Steps: Press and hold PB1~PB4 and rotate power key to START position → constant orange → press PB1 four times (for new systems) or 4-digit security code → slow orange blinks → enter the new 4-digit security code → fast orange blinks → re-enter the same 4-digit security code again → green light.

- d. If you wish to cancel the security code function, then repeat steps a, b, and c and press PB1 four times as your new security code (security code function disabled).
- e. If you do not remember the 4-digit security code, then you must contact your dealer or distributor for further assistance.

4.1.6 I-CHIP

The I-CHIP functions in a way that is very similar to a SIM card inside a mobile phone, which stores system information such as your telephone number, account number, phone book and other settings. The I-CHIP works exactly the same way, as it stores information such as system serial number/ID codes, channel configurations and push button configurations.

When replacing a transmitter handset, just take the I-CHIP out of the old transmitter and install it into the new one (refer to Fig. 11 below). For a complete information transfer, make sure both the Channel and Function dip-switches are set to all "1". If both dip-switches are set to all "1", then the transmitter will operate according to the push button configurations and channel stored inside the I-CHIP. If both the Channel and the Function dip-switches are set to values other than all "1", then the transmitter will operate according to the channel and push button configurations set on these two dip-switches, not the ones stored inside the I-CHIP. Every time the settings on these two dip-switches are changed, the new settings will be stored into the I-CHIP automatically. In this case the previous channel and push button configurations stored inside the I-CHIP will be erased and be replaced by the new settings.

For safety purposes, the system serial number/ID code stored inside the I-CHIP cannot be changed directly on the transmitter encoder board. Only channels and push button configurations can be changed directly on the encoder board via Channel and Function dip-switches. There are only two ways that you can change transmitter serial number/ID codes: 1) via the I-CHIP programming port located on the decoder module inside the receiver unit (please refer to page 34 on how to program the I-CHIP [serial number/ID code] via receiver unit) or 2) via an external I-CHIP programmer or duplicator unit available from the factory. Please ask your local dealer for assistance if your system requires serial number/ID code adjustments.

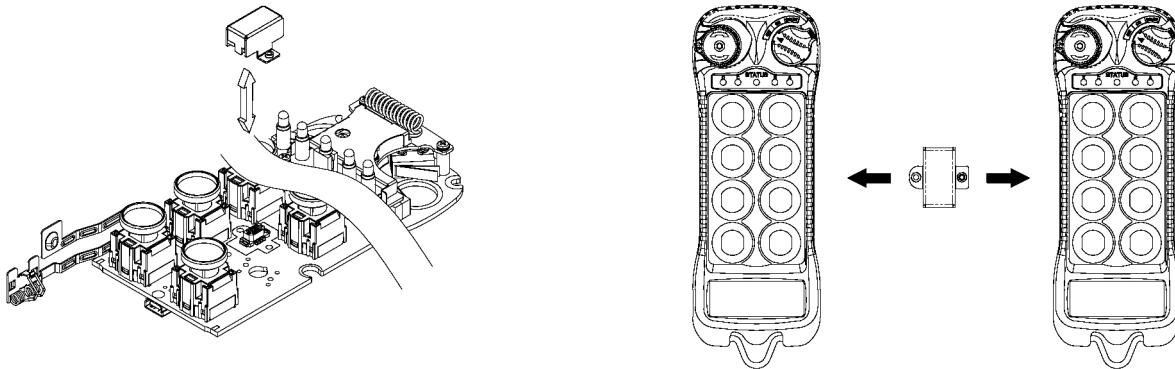

(Fig. 11)

4.2 RECEIVER UNIT

4.2.1 System Channel Settings

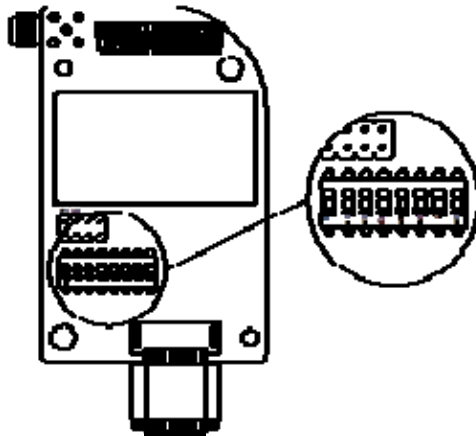

(Fig. 12)

Even though the Flex system is equipped with an automatic channel scanning receiver, the user can also set the receiver channel manually. Please refer to pages 33 and 44 on how the automatic channel scanning receiver works.

Set the receiver channel by adjusting the channel dip-switch located on the receiver module (refer to Fig. 12 above); only the first six (6) positions are used for channel programming (refer to Fig. 13 below). The system channels table located on page 38 illustrates which dip-switch setting corresponds to which channel. Once the receiver channel is altered make sure to change the transmitter channel as well. The channel on both the transmitter and the receiver must be identical in order for system to work. To change the transmitter channel please refer to page 17.

Example:

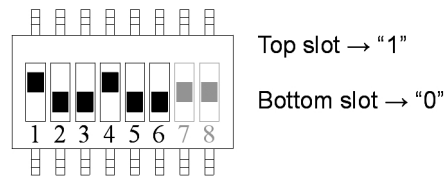

(Fig. 08)

The above dip-switch setting "1 0 0 1 0 0" corresponds to "channel 36" in the system channels table on page 38.

4.2.2 Output Relay Configurations

4.2.2.1 Output Relay Types

1. Three (3) output relays per motion – shared 2nd speed output relay

Output relays with Forward 1st speed (F1), Reverse 1st speed (R1) and Forward/Reverse 2nd speed (F/R2). Forward and Reverse 2nd speed (F/R2) share the same output relay.

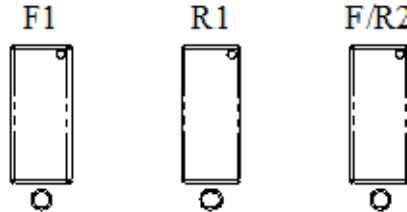

2. Four (4) output relays per motion – separate 1st and 2nd speed output relays

Output relays with Forward 1st speed (F1), Reverse 1st speed (R1), Forward 2nd speed (F2) and Reverse 2nd speed (R2). Forward and Reverse 2nd speed with separate output relays.

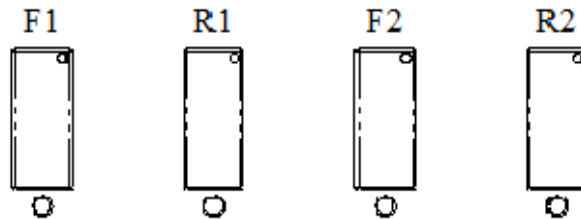

4.2.2.2 Output Relay Actions at 2nd Speed

1. 3-output relays configuration with Closed/Closed contact at 2nd speed

At 2nd speed, both 1st speed (F1 or R1) and 2nd speed (F/R2) output relays are closed (refer to page 34 on how to set to this function).

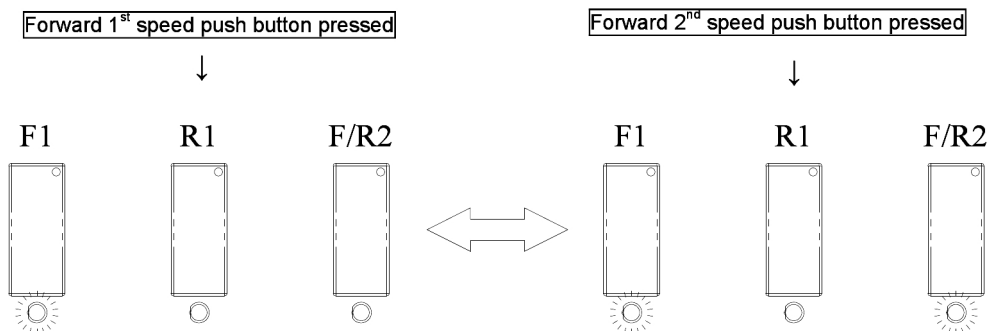

2. 4-output relays configuration with Opened/Closed contact at 2nd speed

At 2nd speed, only the 2nd speed (F2 or R2) output relay is closed (refer to page 34 on how to set to this function).

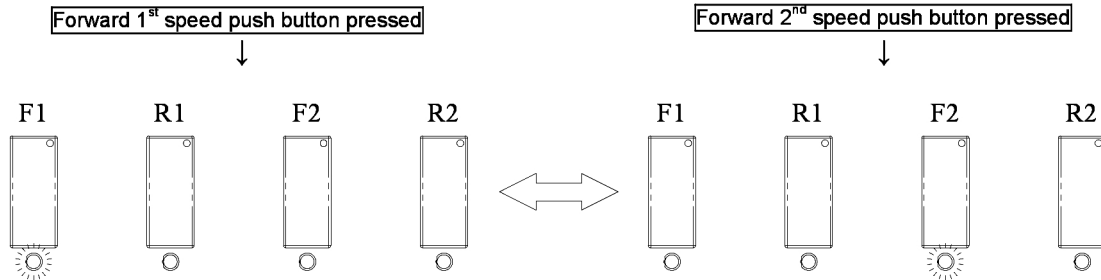

3. 4-output relays configuration with Closed/Closed contact at 2nd speed

At 2nd speed, both 1st speed (F1 or R1) and 2nd speed (F2 or R2) output relays are closed (refer to page 34 on how to set to this function).

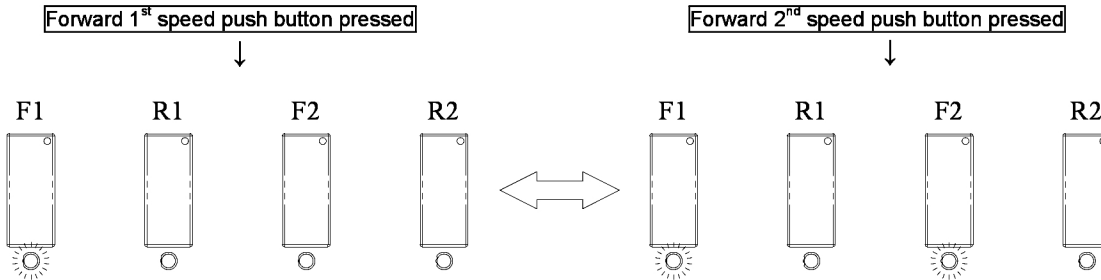

4.2.2.3 ON/OFF Push Button Function

The user can set any of the two adjacent push buttons on the transmitter to behave like a mechanical ON & OFF rocker switch (refer to page 34 on how to set to this function). When “On” output relay is closed (“On” push button pressed), the “Off” output relay will open automatically, or vice versa.



4.2.2.4 START/AUX Function

After initiating the START function the Start position will become an auxiliary function with momentary contact. For an auxiliary applications such as horns or buzzers, please connect it to the FUNC output relay (wire #6) located inside the receiver unit.

4.2.2.5 Magnet ON/OFF Push Button Function

The user can set any of the two adjacent push buttons on the transmitter to control a magnet. To activate the magnet just press the push button with the Magnet symbol. To deactivate the magnet, for safety purposes, you must first press and hold the Magnet push button and then press the OFF push button. Pressing the OFF push button by itself cannot deactivate the magnet (refer to page 34 on how to set to this function).

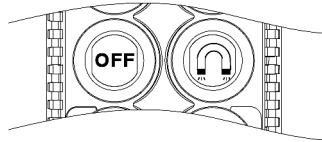

4.2.2.6 Brake Function

When the transmitter push button is released from 2nd speed up to 1st speed, both 1st and 2nd speed output relays will open for up to 1.0 second and then with 1st speed output relay closed thereafter (refer to page 34 on how to set to this function).

4.2.2.7 Momentary Contact

When the push button is released the output relay that corresponds to that push button will open (refer to page 35 on how to set to this function). This type of contact is usually applied to external applications such as horns or buzzers.

4.2.2.8 Toggled Contact

When the push button is released the output relay that corresponds to that push button will remain closed (maintained contact) until next time the user presses the same push button again (refer to page 35 on how to set to this function). This type of contact is usually applied to external applications such as lights.

4.2.2.9 3rd Speed Push Button Function

This function allows the crane to travel an additional step beyond 2nd speed. For example, if the operator is pressing the "UP" push button down to 2nd speed, pressing the 3rd speed push button (with "UP" push button still held at 2nd speed) will toggle between 2nd speed and 3rd speed (refer to page 35 on how to set to this function).

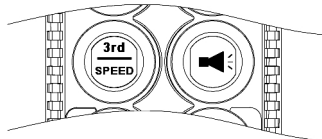

4.2.2.10 Auxiliary STOP Push Button Function

The auxiliary STOP function acts as a 2nd emergency stop button. Other than by emergency stop button and transmitter power key switch, the receiver MAIN is also deactivated when this auxiliary stop push button is pressed (refer to page 35 on how to set to this function).

4.2.2.11 Pitch & Catch Function

This function allows two operators to control one crane from opposite ends of a cross or long travel (refer to page 35 on how to set to this function). When set to "Pitch & Catch," make sure the 2nd transmitter is set to the next upper channel (channel X*+1). For example, if the system is preset at "Ch.01" then the channel of the 2nd transmitter should be set to "Ch.02". Furthermore, the dip-switch position #7 and #8 on the receiving module should be set to "01", as this will allow the receiver to scan only Ch.01 and Ch.02 (please refer to the illustration below). On the other hand, since there are only 62 available channels on the Flex system, the system preset at channel 62 is ineffective because the 2nd transmitter cannot be set to Ch.63. If your system is preset at Ch.62 make sure to change it to another channel.

4.2.3 Receiver Auto-Scanning Settings

Receiver Channel Dip-switch

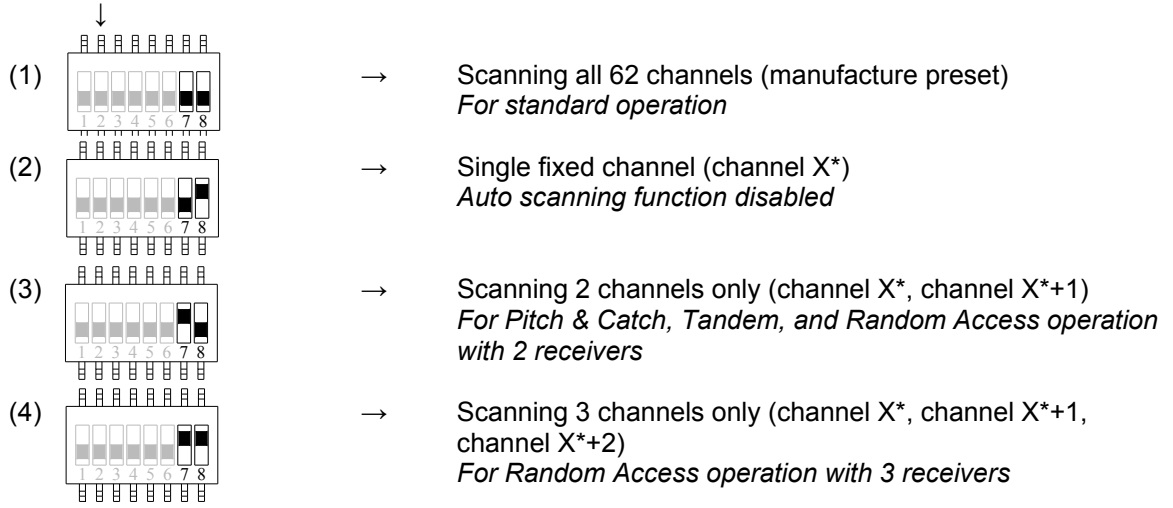

* Channel X → Channel set on the receiving module

Example: If the first 6 dip-switch positions on the receiving module is set to Ch.01 (“000000” or “000001”), when set to 2-channel scanning (type-3 above), then the receiver will only scan Ch.01 and Ch.02.

4.2.4 Dip-Switch Settings

4.2.4.1 Interlocked Functions

Interlocked means the two adjacent push buttons cannot be activated simultaneously as they will cancel each other out. Interlocked settings are usually applied to a crane's forward and reverse motions. Each dip-switch on the decoder module corresponds to one (1) motion or two (2) adjacent push buttons (refer to Fig. 14 & 15 below). Only the first seven (7) dip-switch positions are used (counting from left to right); the 8th dip-switch position (far right) is not used.

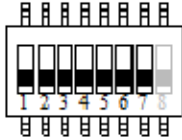

(Fig. 14)

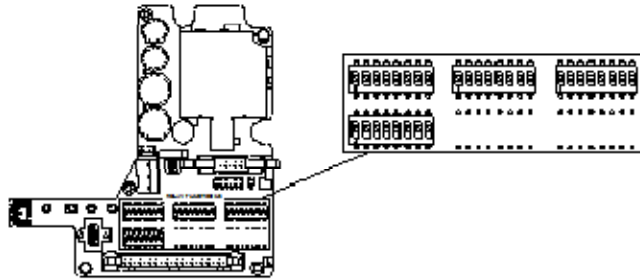

(Fig. 15)

■ Manufacture preset

Dip Settings	Function Descriptions	# of Relays Used
0000000	Normal (single speed only, F2 & R2 relays not used).	2
0000001	Closed/Closed Relay Action at 2 nd Speed (separate 2 nd speed relay).	4
0000010	Closed/Closed Relay Action at 2 nd Speed (shared 2 nd speed relay).	3
0000011	Opened/Closed Relay Action at 2 nd Speed (separate 2 nd speed relay).	4
0000110	On (right button) & Off (left button).	2
0001000	On & Off affected by the E-stop command. When E-stop command is initiated, the Off relay is activated.	2
0001001	On + Start / Off + Start -- Prior to pressing the button you must first rotate and hold the power key switch at START position to activate On or Off relays.	2
0001010	FWD/REV toggled (latched).	2
0001011	FWD/REV toggled (latched) and affected by the E-stop command.	2
0000111	Safety Magnet On & Off.	2
0100001	Closed/Closed + Brake.	4
0100010	Closed/Closed Relay Action + Brake.	3
0100011	Opened/Closed Relay Action + Brake.	4

4.2.4.2 Non-Interlocked Functions

Contrary to interlocked settings, non-interlocked settings allow the two adjacent push buttons be used simultaneously. Non-interlocked settings are usually applied to a crane's auxiliary functions such as lights, horns, 3rd speed, auxiliary stops and Pitch & Catch. Each dip-switch on the decoder module corresponds to one (1) motion or two (2) adjacent push buttons (left & right push buttons).

Function Code	Dip Position Setting #1	Dip Position Setting #2 - #4 (left button) & #5 - #7 (right button)	Function Description
A	1	000	Normal (momentary) contact.
B	1	001	Toggled (latching) contact.
C	1	010	Acceleration (3 rd speed).
D	1	100	Normal + Start function. For added safety, you must first rotate and hold the power key switch at "START" position and then press the intended push button at the same time to activate the output relay.
E	1	110	Pitch & Catch
F	1	111	Auxiliary Stop.

Example #1: Left button (set to function code A) / right button (set to function code A) → **1 000 000**
 Example #2: Left button (set to function code B) / right button (set to function code B) → **1 001 001**
 Example #3: Left button (set to function code A) / right button (set to function code C) → **1 000 010**
 Example #4: Left button (set to function code F) / right button (set to function code A) → **1 110 000**

NOTE: When set to Pitch & Catch function, make sure the 2nd transmitter is set to the next upper channel. For example, if the system is preset at Ch.01, then the 2nd transmitter should be set to Ch.02. Furthermore, you must also set the dip-switch on the receiving module (position #7 & #8) to "10" position (2-channel scanning), please refer to page 29.

4.2.5 Jumper Settings

Jumper settings are applied to functions such as mainline-disconnect time, Start function, transmitter push button layout, system information (serial number/ID code) programming and system testing. The jumpers #1- #7 are located on the decoder module above the four (4) dip-switches (refer to Fig.16 below).

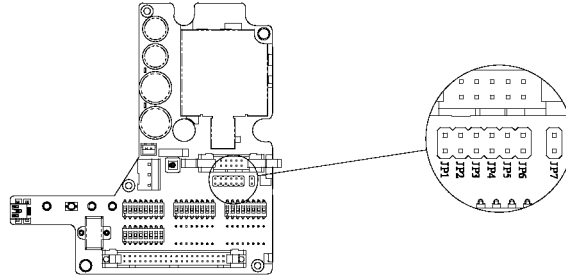

(Fig. 16)

■ Manufacture preset

Jumper Settings		Function
JP3 (Blank)		After 1 or 3 minutes of transmitter inactivity (MAIN deactivated), press any push button on the transmitter to reactivate the receiver MAIN.
JP3 (Inserted)		After 1 or 3 minutes of transmitter inactivity (MAIN deactivated), rotate the transmitter power key-switch to "START" position to reactivate the receiver MAIN.
JP4 (Blank)	JP5 (Blank)	Standard right-to-left push button configuration for all models.
JP4 (Inserted)	JP5 (Blank)	In-line push button configuration (top to bottom) for Flex 8ES/EX.
JP4 (Blank)	JP5 (Inserted)	In-line push button configuration (top to bottom) for Flex 12ES/EX.
JP4 (Inserted)	JP5 (Inserted)	In-line push button configuration (top to bottom) for Flex 4ES/EX.
JP6 (Blank)		Program system serial number/ID code and channel from decoder module to I-CHIP.
JP6 (Inserted)		Program system serial number/ID code and channel from I-CHIP to decoder module.
JP7 (Inserted)		For system test only, receiver MAIN disabled.

4.2.6 I-CHIP Programming Port

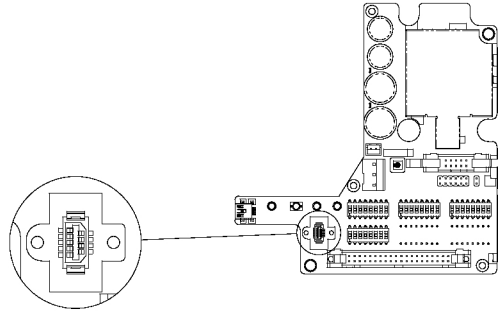

(Fig. 17)

The I-CHIP programming port located on the decoder module (refer to Fig. 17 above) inside the receiver is designed for the purpose of transferring system serial number/ID code either from the I-CHIP to the receiver or vice versa. If you wish to transfer system information from the receiver to the I-CHIP, just insert the I-CHIP onto the programming port (JP6 jumper not inserted), wait until the Status LED on the decoder module turns a constant green (within 2 seconds), and then take the I-CHIP out of the programming port (programming completed). At this time the I-CHIP should also possess the same serial number/ID code as the receiver. If the Status LED on the decoder module displayed a constant red light after inserting the I-CHIP (programming failed), then you must reinsert the I-CHIP one more time. On the other hand, if you wish to transfer system information from the I-CHIP to the receiver, then you must first insert JP6 jumper prior to inserting the I-CHIP, then wait for the green light to appear on the Status LED. At this time the receiver should also possess the same system information as the I-CHIP. Please note that the receiver unit must be powered in order to proceed with the programming.

4.2.7 Voltage Settings

Always check the voltage setting is correct for your application prior to installation (refer to Fig. 18 below).

- Position 1 → 110-120VAC
- Position 2 → 220-240VAC or 24VAC*
- Position 3 → 380-400VAC or 42VAC*
- Position 4 → 410-460VAC or 48VAC* or 12-24VDC**

* For system with 24/42/48VAC power supply.

** For system with 12 - 24VDC power supply.

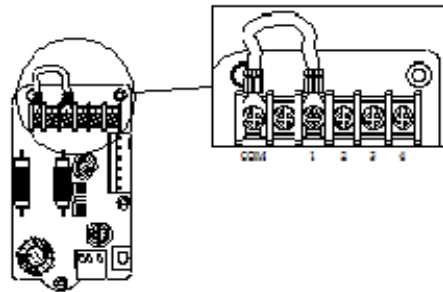

(Fig. 18)

F9 and F10 power fuse ratings:

FUSE #	110 - 120VAC	220 - 240VAC	380 - 400VAC	410 - 460VAC	24VAC	42 & 48VAC	12 - 24VDC
F9	1.0A (red)	1.0A (red)	1.0A (red)	0.5A (blue)	3.0A (yellow)	2.0A (purple)	2.0A (purple)
F10	1.0A (red)	1.0A (red)	1.0A (red)	0.5A (blue)	3.0A (yellow)	2.0A (purple)	2.0A (purple)

* Output relay fuse → 5.0A (clear)

5. SYSTEM CHANNELS TABLE

Channel	Frequency	Dip-switch Setting	Channel	Frequency	Dip-switch Setting
01	433.000MHZ	000000	32	433.775MHZ	100000
01	433.000MHZ	000001	33	433.800MHZ	100001
02	433.025MHZ	000010	34	433.825MHZ	100010
03	433.050MHZ	000011	35	433.850MHZ	100011
04	433.075MHZ	000100	36	433.875MHZ	100100
05	433.100MHZ	000101	37	433.900MHZ	100101
06	433.125MHZ	000110	38	433.925MHZ	100110
07	433.150MHZ	000111	39	433.950MHZ	100111
08	433.175MHZ	001000	40	433.975MHZ	101000
09	433.200MHZ	001001	41	434.000MHZ	101001
10	433.225MHZ	001010	42	434.025MHZ	101010
11	433.250MHZ	001011	43	434.050MHZ	101011
12	433.275MHZ	001100	44	434.075MHZ	101100
13	433.300MHZ	001101	45	434.100MHZ	101101
14	433.325MHZ	001110	46	434.125MHZ	101110
15	433.350MHZ	001111	47	434.150MHZ	101111
16	433.375MHZ	010000	48	434.175MHZ	110000
17	433.400MHZ	010001	49	434.200MHZ	110001
18	433.425MHZ	010010	50	434.225MHZ	110010
19	433.450MHZ	010011	51	434.250MHZ	110011
20	433.475MHZ	010100	52	434.275MHZ	110100
21	433.500MHZ	010101	53	434.300MHZ	110101
22	433.525MHZ	010110	54	434.325MHZ	110110
23	433.550MHZ	010111	55	434.350MHZ	110111
24	433.575MHZ	011000	56	434.375MHZ	111000
25	433.600MHZ	011001	57	434.400MHZ	111001
26	433.625MHZ	011010	58	434.425MHZ	111010
27	433.650MHZ	011011	59	434.450MHZ	111011
28	433.675MHZ	011100	60	434.475MHZ	111100
29	433.700MHZ	011101	61	434.500MHZ	111101
30	433.725MHZ	011110	62	434.525MHZ	111110
31	433.750MHZ	011111	I-CHIP		111111*

* When set to all "1" the priority goes to the channel assigned inside the I-CHIP.

6. RECEIVER INSTALLATION

6.1 OUTPUT RELAY CONTACT DIAGRAM

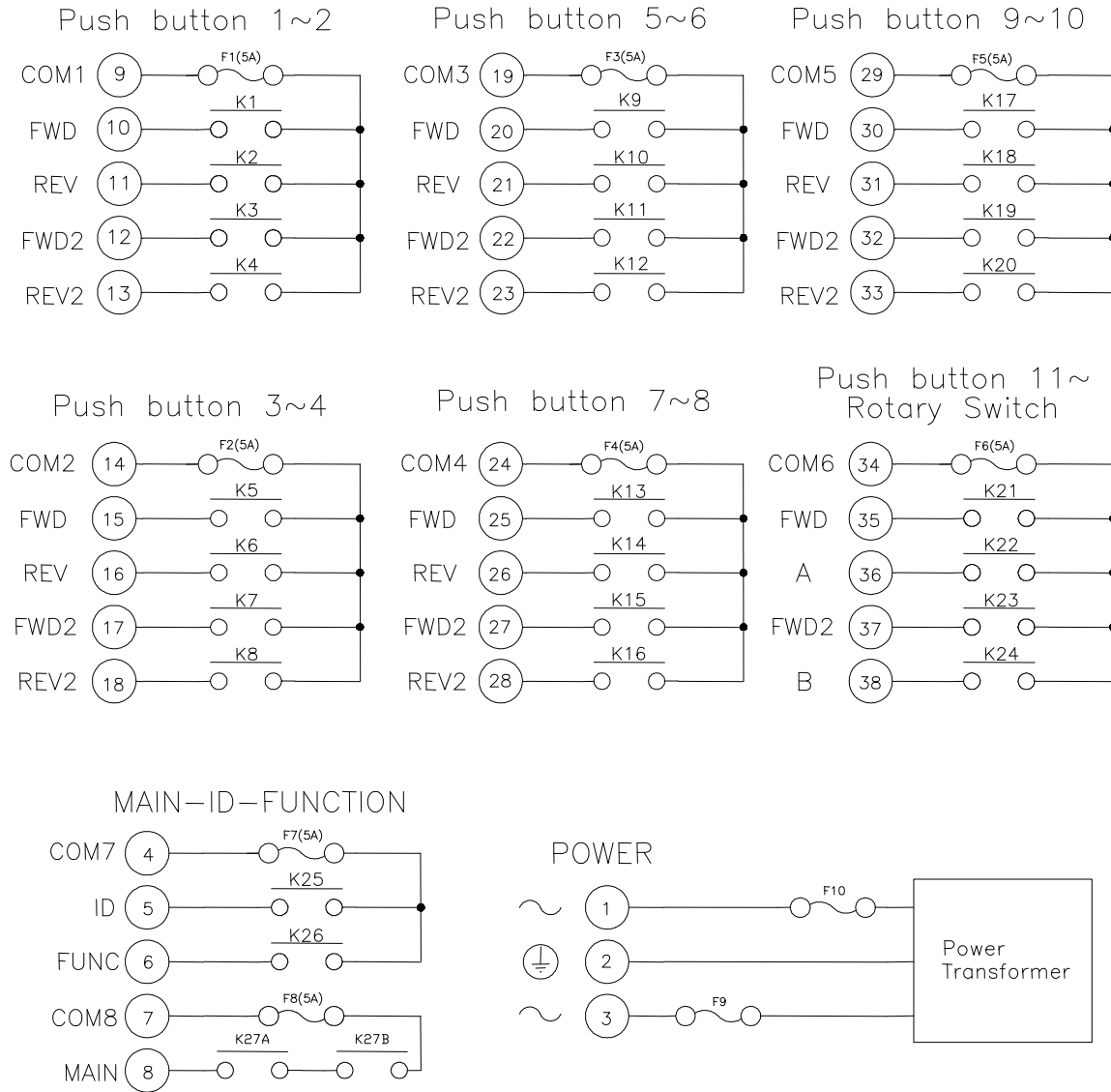

- For the 3-relay (shared 2nd speed) and 4-relay (separate 2nd speed) configuration please refer to page 30.
- For the 4-relay closed/closed and 4-relay opened/closed relay configuration please refer to page 30.
- For different voltage settings please refer to page 37.
- For F9 and F10 power fuse ratings please refer to page 37.
- For 12-24VDC power supply, wire #1 corresponds to the negative charge (-) and wire #3 corresponds to the positive charge (+). Wire #2 is for GROUND.

6.2 PRE-INSTALLATION PRECAUTIONS

1. Make sure the transmitter and the receiver have identical serial number/ID codes and channels.
2. Make sure the receiver is not set to the same channel as any other systems in use in the surrounding area.
3. Make sure that the crane or equipment is working properly prior to installation.
4. Make sure the power source to the receiver is set correctly.
5. Switch off the main power source to the crane or equipment prior to installation.

6.3 STEP-BY-STEP INSTALLATION

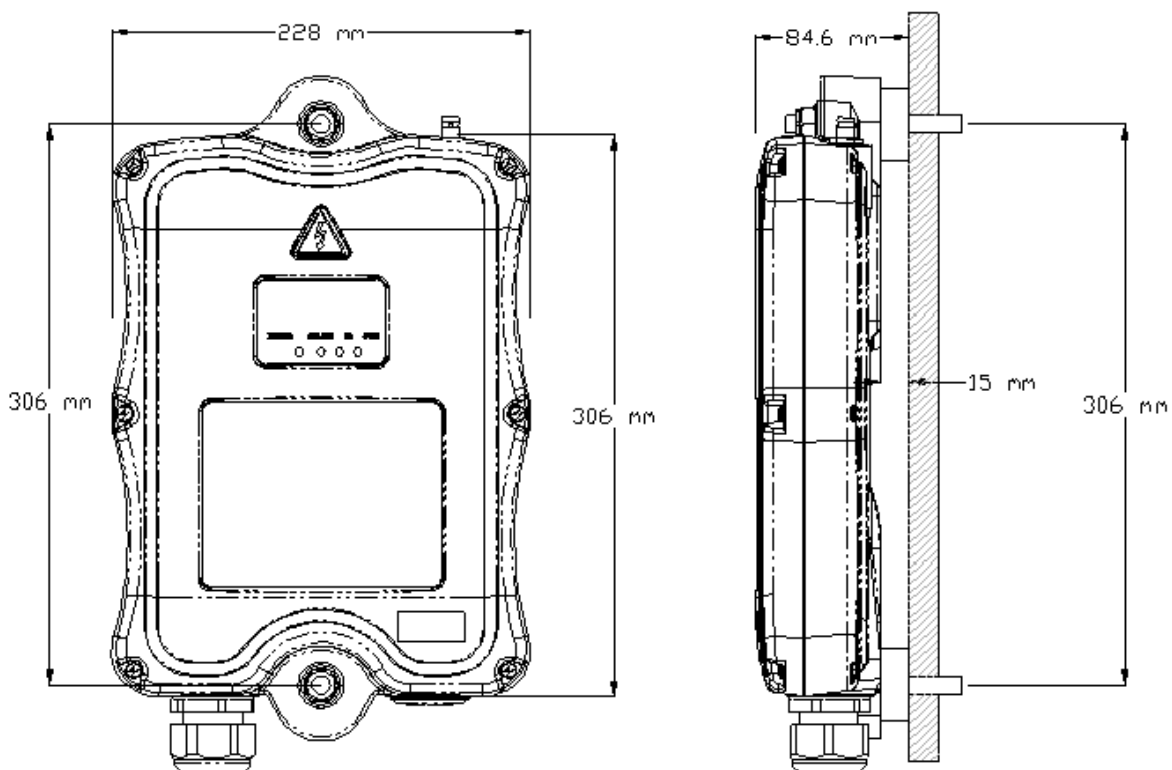

(Fig. 19)

1. For best reception the location of the receiver should be visible to the operator at all time.
2. The location selected should not be exposed to high levels of electric noise. Mounting the receiver next to an unshielded variable frequency drive may cause minor interference. Always locate the receiver as far away from variable frequency drives as possible.

3. Ensure the selected location has adequate space to accommodate the receiver (refer to Fig. 19 on page 40). If an external antenna is used, always locate the receiver where the antenna is free from any obstacles from all directions to avoid the possibility of antenna damage (refer to diagram at right).
4. When installing an external antenna you must connect the SMA jack located inside the receiver and make sure to set the jumper to "EXT" position (refer to diagram below).

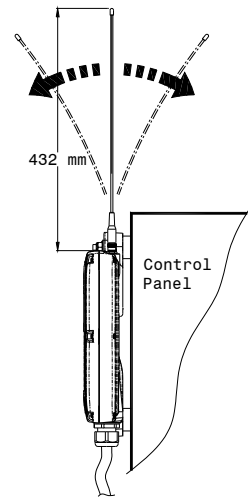
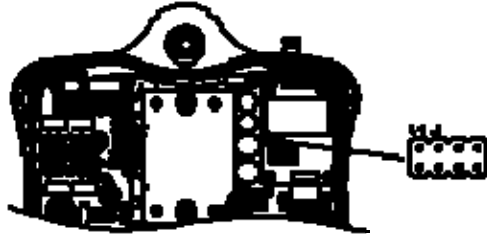

5. For better reception, make sure the receiver is in an upright position.
6. Drill two holes (10mm in diameter) on the control panel or location where the receiver is to be installed (refer to Fig. 19 on page 40).
7. Make sure the two bolts are tightened after installation.
8. For system wiring please refer to page 39.

6.4 SYSTEM TESTING

1. Turn on the power source to the receiver and test the MAIN relay output by pressing the red emergency stop button and observe that it properly opens and closes the mainline disconnect contactor.
2. Test the operation of each function to ensure it corresponds to the transmitter direction labels or the pendant it is replacing.
3. Test the limit switches (if any) to see if they are working properly.
4. If your new remote control is replacing an existing pendant, make sure it is completely disconnected and placed in a safe location to prevent unwanted control commands.

7. Operating Procedure

7.1 TRANSMITTER OPERATION

7.1.1 General Operating Procedure

- a. Reset the red emergency stop button located on the top left hand side of the transmitter handset by rotating it either clockwise or counter clockwise. The red button will pop up.

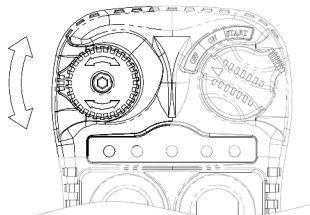

- b. Turn on the transmitter power by inserting the black-colored key into the power key slot (located on the top right hand side of the transmitter handset) and rotate it clockwise to the "On" position.

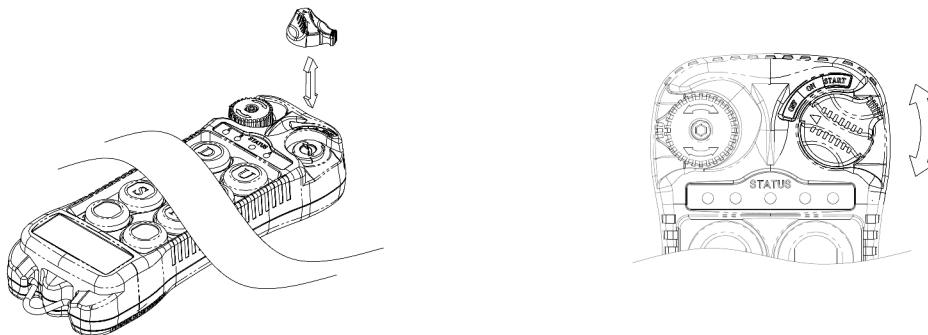

- c. After turning on the transmitter power, check the Status LED on the transmitter handset for any sign of system irregularities (refer to "Status Light Indicators & Warnings" on page 46). If the system is normal, the Status LED will light up green for two (2) seconds.
- d. If there are no signs of any system irregularities, then rotate the power key-switch further to START position for up to 1.0 second to activate all transmitter push button functions and as well as the receiver MAIN. Then press any push button on the transmitter to begin operation. Pressing any push button prior to initiating the START command will result in no signal transmitted (blinking orange light).

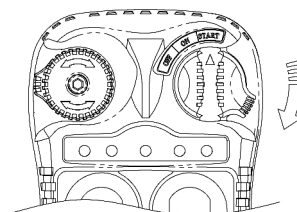

- e. In case of an emergency, pressing down the red emergency stop button will immediately disconnect the receiver MAIN and as well as the transmitter power. To resume operation, rotate the red button clockwise or counter clockwise, it will pop up. Then rotate the power key-switch to START position for up to 1.0 second to activate all transmitter push button functions and the receiver MAIN. Please note that every time when you turn the transmitter power off and back on again, or after resetting the emergency stop button, all push button functions will be locked to avoid any unintentional controls. For safety, initiating the START command after turning on the transmitter power or after resetting the emergency stop button is strictly required.
- f. After 1 minute of inactivity (push button not pressed) the receiver MAIN will be disconnected temporarily. To resume operation, just press any push button on the transmitter to resume operation (depending on JP3 setting on page 36). If this 1-minute inactivity time is not sufficient for your application, you can also extend this inactivity time from 1 minute up to 3 minutes (refer to Continuous Transmitting Time Adjustment on page 18). The receiver MAIN will also be disconnected temporarily when the receiver encounters strong radio interference or when the operator is controlling the crane or equipment beyond the transmitting range.
- g. To turn off the transmitter power just rotate the power key to “Off” position, it will disconnect the transmitter power and the receiver MAIN altogether.

7.1.2 Rotary Select A/B Operating Procedure

This changeover function is designed specifically for crane systems with dual hoists and/or trolleys. Switch between the main and auxiliary hoists simply by rotating the selector switch to either A, B, or A+B. For system wiring please refer to page 39.

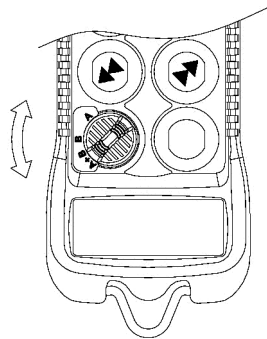

7.1.3 Push Button Select A/B Operating Procedure

Pressing the “Select A/B” push button will toggle between output relay A, B and A+B respectively. There are 4 different types of Select A/B sequences available, please refer to page 20 for instructions on how to set Select A/B functions.

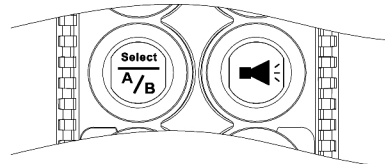
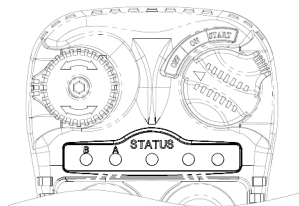

7.1.4 3rd Speed Push Button Operating Procedure

When a push button is held at 2nd speed, pressing the 3rd Speed push button one time will activate the 3rd speed output relay (toggled). If the operator wants 2nd speed again, just press the 3rd Speed push button one more time.

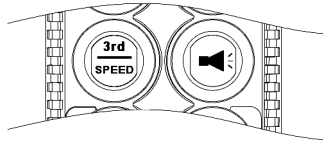

7.1.5 Pitch & Catch Operating Procedure

To release control of the crane, press the "Pitch" push button. To take over control of the crane, rotate the power key switch to the "Catch" position for up to 2 seconds. The second operator cannot take control of the crane unless the first operator presses the "Pitch" push button (2.0 seconds). If the operator unintentionally presses the "Pitch" push button during operation, just rotate the power key to the "Catch" position for up to 2 seconds to regain control.

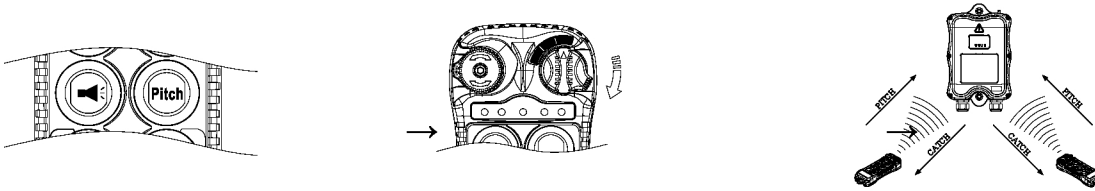

7.1.6 Automatic Channel Scanning Operating Procedure

After changing the transmitter channel (refer to page 15), turn on the transmitter power, rotate the power key switch to the "Start" position, and hold it there for up to 1 minute. Within this 1-minute period the receiver will search (channel 01 ~ channel 62) and lock onto the newly selected transmitter channel automatically. Please note that in order for the receiver to switch to auto-scanning mode, you must first deactivate the receiver MAIN by shutting off the transmitter power or press down the emergency stop button before changing the transmitter channel. Please refer to page 33 if you do not want the receiver to auto-scan all 62 channels.

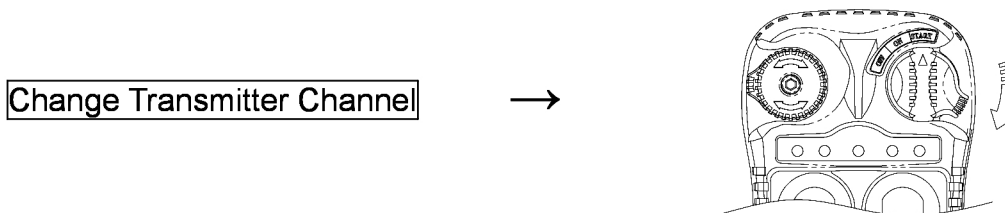

7.1.7 Changing Transmitter Batteries

Change the transmitter batteries by unscrewing the battery cover located on the backside of the transmitter (refer to Fig. 20 below). During battery installations make sure that the blue ribbon is centered between the two batteries. After changing the batteries make sure that all screws are tightened to avoid water, moisture, dirt, grease, or other liquid penetration.

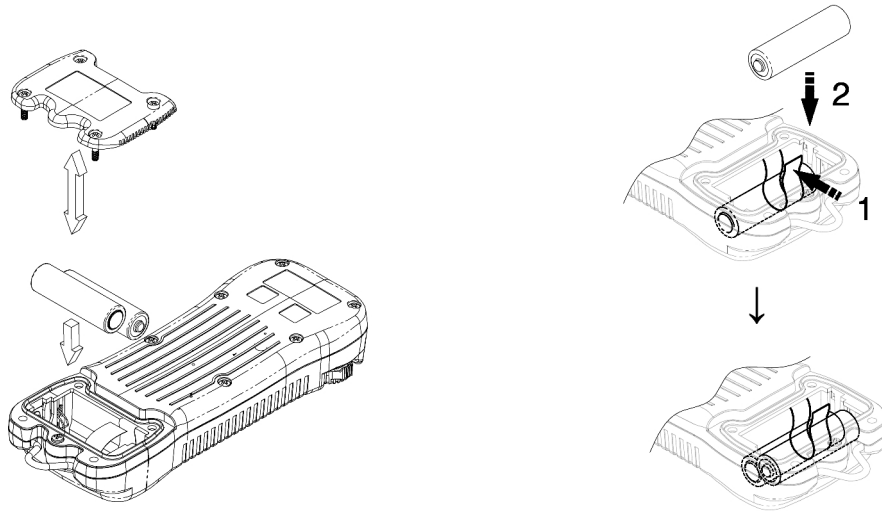

(Fig. 20)

7.2 STATUS LIGHT INDICATORS & WARNINGS

7.2.1 Transmitter STATUS Light Indication

Type	Display Type	Indication
1	Constant red	Voltage below 1.9V at initial power on - transmitter power and receiver MAIN shuts off.
		Voltage below 1.8V during operation - transmitter power and receiver MAIN shuts off.
2	1 red blink followed by a 2-second pause	Voltage goes below 1.85V during operation - change batteries immediately.
3	2 red blinks followed by a 2-second pause	The push button is defective after turning on the transmitter power.
4	No light displayed	When a defective push button condition occurs (2 red blinks, type 3 above), find out which push button is defective by pressing all the push buttons on the transmitter one at a time. If the push button is in good working order, the LED will not light up when pressed. If the push button is defective the LED will continue to display 2 red blinks when pressed.
5	3 red blinks followed by a 2-second pause	EEPROM error.
6	4 red blinks followed by a 2-second pause	Transmitting error; system cannot lock on to the designated channel.
7	Constant green for up to 2 seconds	Transmitter power on with no faults detected
8	Blinking green	Transmission in progress
9	Blinking orange	Transmitter push button functions locked.

7.2.2 Receiver STATUS Light Indication

Type	Display Type	Indication
1	Fast green blinks	Decoding in process
2	Slow green blinks	Decoding on standby
3	Two red blinks	Receiver MAIN is jammed or defective
4	Fast red blinks	Incorrect transmitter serial number/ID code
5	Constant red	Receiver under-voltage, LV output relay activated
6	No light displayed	Decoding microprocessor is defective

7.2.3 Receiver SQ Light Indication

Type	Display Type (Red)	Indication
1	Fast blinks	Transmission received
2	Completely off	No transmission
3	Blinks intermittently	Other radio interference

7.2.4 Receiver POWER Light Indication

Type	Display Type (Red)	Indication
1	On	Power to receiver
2	Off	No power to receiver

7.2.5 Receiver COM Light Indication

Type	Display Type (Red)	Indication
1	On	Power to relay board
2	Off	No power to relay board

7.3 TROUBLESHOOTING TIPS

Problems	Possible Reasons	Suggestions
No response when transmitter push button is pressed (Improper startup & settings)	Transmitter low battery power	Check the transmitter battery level.
	Emergency stop button activated prior to startup	Prior to turning on the transmitter power switch make sure that the red emergency stop button is elevated.
	Transmitter push button functions locked	Initiate the Start command by rotating the power key-switch to START position.
	Incorrect system RF channel	Check and make sure that the transmitter handset and receiver unit both have the same channel.
	Incorrect system serial number/ID code	Check and make sure that the transmitter handset and receiver unit both have the same serial number/ID code.
	System out of range	Make sure that the startup procedure is initiated within 100 meters (300 feet) from the receiver location.
No response when transmitter push button is pressed (Damaged hardware)	Defective transmitting and receiving module	Check the SQ display on the face of the receiver unit. If it does not light up when the push button is pressed then either the transmitting or receiving module is defective. First replace the transmitting module. If SQ display is still not lit when the push button is pressed then go ahead and replace the receiving module.
	Defective encoder board or decoder module	If still no response, then replace the transmitter encoder board. If still doesn't work then the decoder module is defective.
No AC power to the receiver	Incorrect input voltage	Make sure the source voltage is set correctly.
	Blown fuse	Check for any blown fuse.
	Incorrect wiring	Check input voltage connection.
Outputs do not correspond to transmitter	Incorrect output connection	Check the system wiring again. Please refer to the output contact diagram inside this manual or on the receiver cover.

8. SYSTEM SPECIFICATIONS

Frequency Range	:	433 - 434 MHz																		
Frequency Deviation	:	12.5 KHz																		
Number of Channels	:	62 channels																		
Modulation	:	Digital Frequency Modulation based on Manchester Code, 20bit address, 32bit CRC Parity Check and Hamming Code.																		
Encoder & Decoder	:	Microprocessor-controlled																		
Transmitting Range	:	>100 Meters / 300 Feet																		
Frequency Control	:	Synthesized PLL (Phase Lock Loop)																		
Receiver Type	:	Frequency Auto Scanning																		
Receiver Sensitivity	:	-116dBm																		
Antenna Impedance	:	50 ohms																		
Responding Time	:	60 Milliseconds (average)																		
Transmitting Power	:	0.3mW																		
Enclosure Type	:	NEMA-4X																		
Enclosure Rating	:	IP-66																		
Output Contact Rating	:	250V @ 8 Amps																		
Transmitter Operating Voltage	:	DC 3.0V																		
Receiver Power Consumption	:	11.0 VA																		
Receiver Supply Voltage	:	<table> <tr> <td>Voltage Setting</td> <td>Min ~ Max</td> </tr> <tr> <td>24VAC</td> <td>(22 ~ 26VAC)</td> </tr> <tr> <td>42VAC</td> <td>(38 ~ 46VAC)</td> </tr> <tr> <td>48VAC</td> <td>(43 ~ 53VAC)</td> </tr> <tr> <td>110VAC</td> <td>(104 ~ 126VAC)</td> </tr> <tr> <td>220VAC</td> <td>(207 ~ 253VAC)</td> </tr> <tr> <td>380VAC</td> <td>(351 ~ 429VAC)</td> </tr> <tr> <td>410VAC</td> <td>(400 ~ 480VAC)</td> </tr> <tr> <td>12/24VDC</td> <td>(9 ~ 36VDC)</td> </tr> </table>	Voltage Setting	Min ~ Max	24VAC	(22 ~ 26VAC)	42VAC	(38 ~ 46VAC)	48VAC	(43 ~ 53VAC)	110VAC	(104 ~ 126VAC)	220VAC	(207 ~ 253VAC)	380VAC	(351 ~ 429VAC)	410VAC	(400 ~ 480VAC)	12/24VDC	(9 ~ 36VDC)
Voltage Setting	Min ~ Max																			
24VAC	(22 ~ 26VAC)																			
42VAC	(38 ~ 46VAC)																			
48VAC	(43 ~ 53VAC)																			
110VAC	(104 ~ 126VAC)																			
220VAC	(207 ~ 253VAC)																			
380VAC	(351 ~ 429VAC)																			
410VAC	(400 ~ 480VAC)																			
12/24VDC	(9 ~ 36VDC)																			
Operating Temperature	:	-25°C -- 75°C / -13°F -- 167°F																		
Transmitter Dimension	:	230mm (L) x 69mm (W) x 35mm (H)																		
Receiver Dimension	:	363mm (L) x 228mm (W) x 70mm (H)																		
Transmitter Weight	:	296g / 10.4oz																		
Receiver Weight	:	2.5kg / 5.5lb																		