



Telemotive SLTX Transmitter

Remote Crane Controls

Instruction Manual



MAGNETEK
MATERIAL HANDLING

Telemotive

TC18KSLTX-0 Rev. C January 2006
Part Number: 178-01000
©Copyright 2006 Magnetek Material Handling

This page intentionally left blank.

Table of Contents

1-	Service Information	1-1
	1. Service Information	1-1
2-	Radio Controlled Crane Safety	2-1
	1. Warnings, Cautions And Notes	2-1
	2. Critical Installation Considerations	2-1
	3. General	2-2
	4. Persons Authorized To Operate Radio Controlled Cranes	2-2
	5. Training Checklist For Crane Operators	2-2
	6. Operating Area	2-3
	7. Transmitter Unit	2-3
	8. Operating The Crane	2-3
	9. Boarding The Crane	2-4
	10. Crane Repair	2-4
	11. Using The Crane As A Work Platform	2-5
	12. Condition Of The Radio Controlled Crane	2-6
	13. Battery Disposal	2-6
3-	General System Information	3-1
	1. General System Information	3-1
	2. FCC Regulations	3-1
	3. Signaling	3-1
	4. Part 90 TMS And Continuous Carrier	3-1
	5. Part 15 TMS	3-1
	6. Receiver Unit	3-1
	7. Part 15 Specifications	3-1
	8. Time Multiplex Shared (TMS) System Software	3-2
4-	SLTX Transmitter Operation	4-1
	1. Power On/Off Switch	4-1
	2. E-Stop	4-1
	3. Motion Push Buttons, Joysticks Or Levers	4-1
	4. Battery Monitor LED Indicator	4-1
	5. Time-Out-Timer	4-1
	6. Key Switch (For Models So Equipped)	4-1
	7. Servicing Information	4-2
5-	SLTX Transmitter Servicing	5-1
	1. SLTX Transmitter Setup Information	5-1
	2. Setting Access Code	5-1
	3. Programming Switches	5-1
	4. To Check Data	5-3
	5. Battery Monitor	5-3
	6. Analog Voltage Reference	5-3
	7. Transmit LED	5-3
	8. Batteries and Charger	5-3
	9. Replacement Parts	5-3

Section 1 – Service Information

1-1. Service Information.

Thank you for your purchase of Magnetek's Telemotive® brand SLTX Radio Remote Crane Control. Magnetek has set a whole new standard in radio-remote performance, dependability, and value with this unique new line of belly box transmitters. Without a doubt, our Telemotive SLTX is the ultimate solution for having precise, undeterred, and safe control of your material.

If your product ever needs modification or service, please contact one of our representatives at the following locations:

U.S. Service Information

For questions regarding service or technical information contact:

**1-866-MAG-SERV
(1-866-624-7378).**

Magnetek Material Handling
N49 W13650 Campbell Drive
Menomonee Falls, WI 53051

Telephone: 800-288-8178

Website: www.magnetekmh.com
e-mail: info@magnetekmh.com

Fax Numbers:

Main: 800-298-3503
Sales: 262-783-3510
Service: 262-783-3508

Canada Service Information:

4090B Sladeview Crescent
Mississauga, Ontario
L5L 5Y5 Canada
Phone: 1-800-792-7253
Fax: 1-905-828-5707

Section 2 - Radio Controlled Safety

Warnings, Cautions And Notes.

Through out this document WARNING, CAUTION and NOTE statements have been deliberately placed to highlight items critical to the protection of personnel and equipment.

WARNING – A warning highlights an essential operating or maintenance procedure, practice, etc. which if not strictly observed, could result in injury or death of personnel, or long term physical hazards. Warnings are highlighted as shown below:



CAUTION – A caution highlights an essential operating or maintenance procedure, practice, etc. which if not strictly observed, could result in damage to, or destruction of equipment, or loss of functional effectiveness. Cautions are highlighted as shown below:



NOTE – A note highlights an essential operating or maintenance procedure, condition or statement. Notes are shown as below:

NOTE

WARNINGS, CAUTIONS AND NOTES SHOULD NEVER BE DISREGARDED.

The safety rules in this section are not intended to replace any rules or regulations of any applicable local, state, or federal governing organizations. The following information is intended to be used in conjunction with other rules or regulations already in existence. It is important to read all of the safety information contained in this section before installing or operating the Radio Control System.

2-1. Critical Installation Considerations.

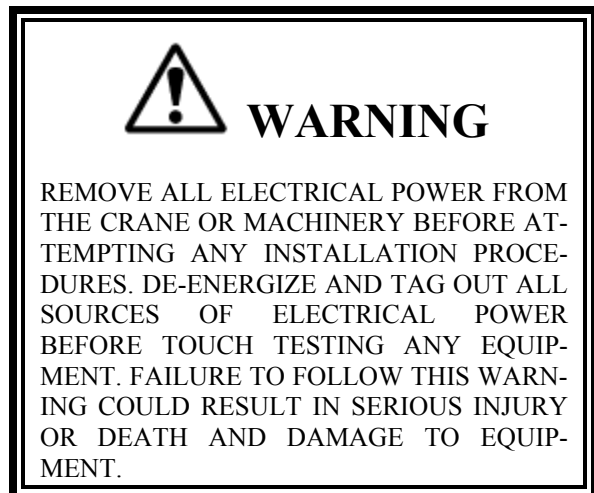
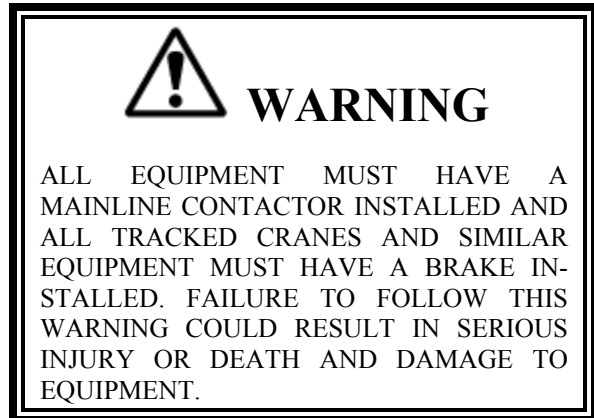

Section 2 - Radio Controlled Safety (Continued)



WARNING

THE DIRECT OUTPUTS OF THIS PRODUCT ARE NOT DESIGNED TO INTERFACE DIRECTLY TO TWO STATE SAFETY CRITICAL MAINTAINED FUNCTIONS, I.E., MAGNETS, VACUUM LIFTS, PUMPS, EMERGENCY EQUIPMENT, ETC. A MECHANICALLY LOCKING INTERMEDIATE RELAY SYSTEM WITH SEPARATE POWER CONSIDERATIONS MUST BE PROVIDED. FAILURE TO FOLLOW THIS WARNING COULD RESULT IN SERIOUS INJURY OR DEATH AND DAMAGE TO EQUIPMENT.

2-2. General.

Radio controlled overhead cranes and other material handling equipment operate in several directions. They are large, bulky pieces of equipment that handle heavy loads efficiently at high speeds. Quite frequently, the equipment is operated in areas where people are working on the floor below. The crane operator must exercise extreme caution at all times. Workers must constantly be alert to avoid accidents. The following rules have been included to indicate how your careful and thoughtful actions may prevent injuries, damage to equipment, or even save a life. If radio controlled material-handling equipment is operated from the cab, special care must be taken to secure the transmitter. Refer to section titled [Section 2-8. Boarding The Crane](#) for specific safety rules.

2-3. Persons Authorized To Operate Radio Controlled Cranes.

Only properly trained persons designated by management should be permitted to operate radio-controlled cranes.

Radio controlled cranes should not be operated by any person who cannot read or understand signs, notices and operating instructions that pertain to the crane.

Radio controlled cranes should not be operated by any person with insufficient eyesight or hearing or by any person who may be suffering from a disorder or illness or is taking any medication that may cause loss of crane control.

2-4. Training Checklist For Crane Operators.

Anyone being trained to operate a radio-controlled crane should possess as a minimum the following knowledge and skills before operating the crane:

The operator should have knowledge of hazards peculiar to crane operation.

The operator should have knowledge of the safety rules for radio-controlled cranes.

The operator should have the ability to judge distance or moving objects.

The operator should have knowledge of the radio transmitter.

The operator should know the limit switch test procedure.

The operator should know, where authorized, instructions for plugging motions.

The operator should have knowledge of the use of crane warning lights and alarms.

The operator should have knowledge of observing crane signal lights.

The operator should be trained to avoid striking any obstructions.

The operator should have knowledge of the proper clearance of lifts or hooks before moving bridge or trolley.

The operator should have knowledge of the proper storage space for radio control box when not in use.

The operator should be trained in transferring radio control box to another person.

The operator should be trained how and when to report unsafe or unusual operating conditions.

The operator should be trained how to exhibit caution in approaching bridge or trolley bumpers.

The operator should know equipment capacity.

The operator should be trained in making lifts below floor level.

Section 2 - Radio Controlled Safety (Continued)

The operator should be trained in making side pulls.

The operator should know how to keep himself and other people clear of lifts and to avoid "pinch" points.

The operator should know cable and hook inspection procedures.

The operator should know procedures for testing hoist, trolley, and bridge brakes.

2-5. Operating Area.

Aisles between equipment, stock, etc., should be free of obstructions so the crane operator can move freely. These aisles should be a minimum of three feet (one meter) wide, or meet local regulations.

Crane operators should always position themselves for the best view of the crane they are controlling. The crane should never be operated blindly. The operator should stay as close to the crane load as possible. Operators should never position themselves in a "pinch" point.

2-6. Transmitter Unit.

Transmitter switches should never be mechanically blocked ON or OFF for any crane motion. When not in use turn the transmitter OFF. A secure storage space should be provided for the transmitter unit and the transmitter unit should always be placed there when not in use. This precaution will prevent unauthorized people from operating the crane.

Spare transmitters should be stored in a secure storage space and only removed from the storage space after the current transmitter in use has been turned OFF, taken out of the service area and secured.

2-7. Operating The Crane.

2-7.1. Pre-operation Test.

At the start of each work shift, or when a new operator takes control of the crane, operators shall do as a minimum the following steps before making lifts with any crane or hoist:

Test the upper-limit switch. Slowly raise the unloaded hook block until the limit switch trips. When checking limit switches the hoist should

be centered over an area free of personnel and equipment.

Visually inspect the hook, load lines, trolley, and bridge as much as possible from the operator's station; in most instances, this will be the floor of the building.

The bridge and trolley brakes should be tested. On transmitter units equipped with two or more speeds, use the "lowest" speed when testing braking devices.

When lifting maximum loads, the crane operator should test the hoist brakes by raising the load a few inches from the floor. If the brakes do not hold, the load should immediately be lowered to the floor.

If provided, test the lower-limit switch.

Test all warning devices.

Test all direction and speed controls for both bridge and trolley travel.

Test all bridge and trolley limit switches, where provided, if operation will bring the equipment in close proximity to the limit switches.

Test the transmitter emergency stop.

Test the hoist brake to verify there is no drift without a load.

If any crane or hoist that fails any of the above tests notify the supervisor and lock out and tag for repair.

2-7.2. General Rules For Operation.

Consult the crane manufacturer, local and governmental regulations for complete rules of operation. In general the following rules apply to remotely controlled cranes:

The limit switches should never be used as a regular stopping device. They are intended to be protective devices.

Do not make lifts in excess of the equipment rated capacity.

The bridge and trolley should be centered directly over the load when the load is raised to prevent swinging when making lifts.

Section 2 - Radio Controlled Safety (Continued)

A crane designed for this purpose and only with supervisor permission should make side pulls. When a lift is being made, the crane operator should not be positioned in the line of travel. The crane or hoist should be operated from a position either to the side or opposite from the direction of travel.

When raising or lowering a load, proceed slowly and make certain the load is under control. Tag lines should be used for handling unusual lengths or bulky loads. Remove slack from chains or slings gradually. Make certain all personnel are clear before making a lift.

The crane operator should keep all body parts away from the lift and should never be positioned under the lift.

Do not make a lift or move a load if anyone is in a location where they could be struck by the crane or the load.

If the crane operator is being helped, the crane should not be moved until the helper signals they are clear of the crane and its load.

When a load is hanging from the crane hook and the crane is being moved, the crane operator should sound all warning devices frequently.

Loads should not be carried over workers heads. If a worker is in the path of crane travel, the crane operator should stop the crane and clear the area before proceeding.

Runway stops or other cranes should never be bumped into.

When moving the crane, the crane operator should be sure that the hook block and attachments or cables would not catch on nearby equipment. Slings, chains, or cables should never be dragged along the floor.

Unless required for operator safety, gloves should not be worn when operating the transmitter unit.

All loose materials or parts should be removed from the load before starting the lift.

The crane operator should always hoist lifts high enough to clear all equipment and workers.

The crane operator should never permit anyone to ride on the load or hook except when authorized by the supervisor.

When another crane on the same runway is stationary with a load hanging, the crane operator should maintain a safe distance between the stationary crane and the one under their control.

Never leave suspended loads unattended. In an emergency, if the crane is inoperative and a load suspended, notify the supervisor immediately, barricade and post signs on the floor beneath crane and load.

If power to the crane is removed, the crane operator should turn the transmitter unit OFF and keep it OFF until power is restored.

If the crane fails to respond properly, the crane operator should stop operation, turn the transmitter unit OFF and immediately report the condition to their supervisor.

Outdoor cranes, which are subject to movement by wind, should be securely anchored when left unattended. If the crane is equipped with bridge brakes, the parking brake should be set immediately.

2-8. Boarding The Crane.

The crane should not be boarded without permission of the supervisor.

The crane operator should turn off the transmitter and take it with them when boarding the crane.

If more than one person is boarding the crane, one person should be made responsible for ensuring all personnel are off the crane before the system is returned to operation.

2-9. Crane Maintenance And Repair.

Qualified personnel must maintain a regularly, i.e., such as monthly, scheduled crane inspection. During this crane inspection the functionality and safety of the crane remote control must also be tested. The inspection shall include, but be not limited to items listed in [Section 2-11. Condition Of The Radio Controlled Crane](#). Consult crane manufacturer, local and governmental regulations for recommended inspection intervals and proper inspection procedures. Problems noted during this inspection must be repaired before using the crane or the remote control.

Section 2 - Radio Controlled Safety (Continued)

Minor repairs include routine maintenance and repairs such as greasing, cleaning and control troubleshooting. All other repairs should be considered major. If the repair crew consists of more than one person, one person should be designated as the repair crew leader with the following responsibilities. If the repair crew consists of only one person, that person has the following responsibilities:

For minor repairs warning signs should be placed on the floor beneath the crane or suspended from the crane. For major repairs, the floor area below the crane should be roped off.

When major repairs are to take place, all persons operating other cranes on the same or adjacent runways, if any, must be notified prior to starting repairs. Notification should include the nature of the repair, safeguards provided, and movement limitations while repairs are in progress.

When practical, radio controlled cranes which cannot be moved during repairs must be protected against being bumped by other cranes on the runway. Bumpers should be installed on the exposed side or sides of the crane under repair. They should be placed as far away as possible. The location of these bumpers should be indicated by red lights placed so that they are clearly visible to other crane operators traveling on the same runway. When it is not possible to use bumpers, red lights must be placed so they are clearly visible to other crane operators traveling on the same runway to indicate the restricted travel zone. All crane operators on the same runway must be informed of the repair effort and thoroughly instructed to what their operations are limited to and informed they will be notified when repairs are completed.

If any hazard involving the repairmen exists when there is a runway adjacent to the crane under repair, the adjacent runway should be blocked off as described above. When it is necessary to continue crane operation on the adjacent runways warning lights must be installed and be visible to operators of cranes on those runways. All cranes should come to a complete stop prior to entering the restricted area and should proceed through this area only after receiving permission from a signal person designated for this purpose. Access of persons to and from the crane being repaired should be under control of the repair crew leader.

When boarding the crane, the transmitter should be turned OFF and the transmitter should remain with the repair crew leader. The leader should board the crane first, open and lock out the main switch, and then signal the other members of the crew it is safe to board the crane.

If work on the crane is to be done in areas not protected by standard handrails, the repair crew should wear approved safety belts.

All tools and equipment should be moved onto the crane by the use of hand lines. The tools and equipment should be adequately secured to the hand lines.

If it is necessary to have the crane control circuits energized, all power circuits for crane movement must be opened prior to energizing the control circuits.

All personnel and tools should be moved to a safe spot before moving the crane during repairs.

Headroom is at a minimum in some crane cabs and on some crane walkways. Caution should be exercised when boarding or working on cranes. Hard hats should be worn whenever possible.

When repairs are finished, all personnel, tools and repair equipment should be removed before energizing the crane circuits.

2-10. Using The Crane As A Work Platform.

When the crane is to be used as a stationary work platform, follow all rules provided in [Section 2-9. Crane Maintenance and Repair](#). When it is necessary for the crane to be moved from time to time, the crane operator should board the crane with the transmitter unit. The crane operator should ensure all personnel working on the crane are in a secure position before moving the crane to the next workstation. It should also be the crane operator's responsibility to ensure the main switch is open and locked down before work is resumed.

Section 2 - Radio Controlled Safety (Continued)



WARNING

THE CRANE OPERATOR SHOULD NOT ATTEMPT TO REPAIR ANY OF THE ITEMS STATED BELOW. THE CRANE CONDITION SHOULD BE REPORTED TO THE SUPERVISOR. FAILURE TO FOLLOW THIS WARNING COULD RESULT IN SERIOUS INJURY OR DEATH AND DAMAGE TO EQUIPMENT.

2-11. Condition Of The Radio Controlled Crane.

If the crane fails to respond properly, the crane operator(s) should notify their supervisor. When serious conditions are noticed (conditions that make the crane unsafe to operate), the crane should be shut down immediately and the supervisor notified. The following is a list of some of the items that should be included in the report. (See the crane manufacturer for specifics and possible additional items):

Condition of hoisting cable and hook block (broken strands, clipped sheave wheels, etc.).

Condition of brakes (hoist, trolley, and bridge). (No bluing, rivets on shoes showing, glazing, etc.).

Condition of trolley and rail stops.

Condition of bridge structure.

Condition of festoon system.

Broken welds in any part of the crane structure.

Proper fluid levels and lubrication.

Condition of bridge and trolley stops.

Carbon dust or signs burning on the covers of motors.

Indication of fluid, oil or grease leaks.

Condition of rail sweeps.

Walkways required handrails and ladders are in place, sturdy and not loose.

Protective guards are in place for all moving parts.

Alignment of bridge (screeching or squealing wheels indicate bridge is out of line).

Broken, cracked, or chipped rails on trolley or runway.

Condition of limit switches.

Condition of electrical and mechanical control (electrical or mechanical defects which cause faulty operation such as un-commanded stopping or starting of any crane motions, warning devices, lights, or auxiliary functions).

Condition of gears (grinding or squealing may indicate foreign materials in gear teeth or a lack of lubrication).

All controls especially E-STOPS are in place and in working order.

Frequent relay tripping of power circuits.

Mechanical parts loosened by vibration (loose rivets, covers, bolts, etc.).

Uneven riding (worn or damaged wheels).

Condition of collector shoes or bars.

Condition of warning or signal lights and horns. (Burned out or broken).

2-12. Batteries



WARNING

KNOW AND FOLLOW PROPER BATTERY HANDLING, CHARGING AND DISPOSAL PROCEDURES. IMPROPER BATTERY PROCEDURES CAN CAUSE BATTERIES TO EXPLODE OR DO OTHER SERIOUS DAMAGE. FAILURE TO FOLLOW THIS WARNING COULD RESULT IN SERIOUS INJURY OR DEATH AND DAMAGE TO EQUIPMENT.

Section 2 - Radio Controlled Safety (Continued)

2-12.1. Battery Handling.

Use only batteries approved by Telemotive for the specific product.

Do not dispose of a battery pack in fire; it may explode.

Do not attempt to open the battery pack.

Do not short circuit battery.

For intrinsically safe environments only use specified Telemotive intrinsically safe batteries.

Keep the battery pack environment cool during charging operation and storage, (i.e., not in direct sunlight or close to a heating source).

2-12.2. Battery Charging.

For those transmitters equipped with battery chargers, please familiarize all users with the instructions of the charger before attempting to use.

Use only Telemotive approved chargers for the appropriate battery pack.

Do not attempt to charge non-rechargeable battery packs.

Avoid charging the battery pack for more than 24 hours.

Do not charge batteries in a hazardous environment.

Do not short charger.

Do not attempt to charge a damaged battery.

Do not attempt to use a battery that is leaking, swollen or corroded.

Charger units are not intended for outdoor use. Use only indoors.

2-12.3. Battery Disposal.

Before disposing of batteries consult local and governmental regulatory requirements for proper disposal procedures.

Section 3 – General System Information

3-1. General System Information.

The 10K and 18K SLTX transmitter (system) provides remote control of overhead cranes using radio signals. The system consists of a hand held portable battery operated transmitter unit and a fixed station receiver unit.

Each system has its own access code, which permits a receiver unit to respond only to a transmitter unit with the same access code. Up to four transmitters may be used with the same frequency. Each transmitter operating on the same frequency may be operated in close proximity (not less than six feet) to each other.

Access Code: Any received signal, which does not match the receiver access code, is considered invalid by the receiver.

NOTE

DETERMINE IF YOUR SYSTEM IS FCC PART 15 OR PART 90. IF THE RECEIVER HAS THE PART NUMBER 18087 ON THE DOOR OR YOUR TRANSMITTER HAS A PUSH BUTTON FOR ON/OFF RATHER THAN A TOGGLE SWITCH IT IS FCC PART 15.

3-2. FCC Regulations.

There are two types of radio-controlled systems. One is high power licensed (FCC Part 90) and low power unlicensed (FCC Part 15). Both give more than adequate range, security and features; however there are subtle differences in operation required by FCC rules and regulations. It is helpful to know with system type you have to troubleshooting and servicing.

3-3. Signaling (TMS and Continuous).

TMS (Time Multiplexed Signaling) is a Telemotive proprietary high-speed packet data system that transmits data in pulses. Continuous Carrier signaling means the transmitter is continuously transmitting power whether or not a lever or function is activated. Continuous carrier systems tend to be older systems.

3-4. Part 90 (TMS And Continuous Carrier).

For 18K licensed systems, the transmitter unit is frequency modulated, has relatively high power (greater than 100 mW typically) and a license is required under Part 90 of FCC rules and

regulations. The transmitter unit uses crystal-controlled oscillators to set the operating frequency.

3-5. Part 15 (TMS only).

For 10K and 18K systems with part 15 signaling, the transmitter unit is frequency modulated, lower power and is certified under part 15 of FCC rules and regulations. A license is not required for the transmitter or operator. The transmitter unit uses crystal-controlled oscillators to set the operating frequency.

A power down feature turns the transmitter unit OFF if no keys are pressed for an extended (approximately 15 minutes) period of time. The transmitter unit must again be turned ON. A configuration of the transmitter unit is available without automatic timeout.

A LED mounted on the front panel provides battery voltage and data transmission status.

3-6. Receiver Unit.

The receiver unit consists of an RF receiver module, microprocessor control module, output relay/control modules and a power supply.

A power down feature turns the receiver unit OFF if no commands are received for an extended (approximately 15 minutes) period of time. A configuration of the receiver unit is available without automatic time out.

3-7. Part 15 System Specifications.

Channel Designations: (The channels listed here are for reference purposes and are not an indication of production stock. Some channels may take extended delivery. Contact Telemotive for availability).

01.	AK01	439.8 MHz
02.	AK02	439.6 MHz
03.	AK03	439.4 MHz
04.	AK04	439.2 MHz
05.	AK05	439.0 MHz
06.	AK06	438.8 MHz
07.	AK07	438.6 MHz
08.	AK08	438.4 MHz
09.	AK09	438.2 MHz
10.	AK10	438.0 MHz
11.	AK11	437.8 MHz

Section 3 – General System Information (Continued)

12.	AK12	437.6 MHz
13.	AK13	437.4 MHz
14.	AK14	437.2 MHz
15.	AK15	437.0 MHz
16.	AK16	436.8 MHz
17.	AK17	436.6 MHz
18.	AK18	436.4 MHz
19.	AK19	436.2 MHz
20.	AK20	436.0 MHz
21.	AKA00	433.125 MHz
22.	AKA01	433.325 MHz
23.	AKA02	433.525 MHz
24.	AKA03	433.725 MHz
25.	AKA04	433.925 MHz
26.	AKA05	434.125 MHz
27.	AKA06	434.325 MHz
28.	AKA07	434.525 MHz
29.	AKA08	434.725 MHz
30.	AK38	432.4 MHz
31.	AK50	430.0 MHz

sent, and the data rate (baud). Once the packet is sent, the transmitter will turn OFF. This allows for other transmitters to time-share the same frequency when a transmitter has turned OFF. The TMS system software determines the OFF period and repetition rate of the ON period. This allows up to 4 transmitters to share and have equal access to the same frequency, and also allows for reduced battery consumption and extended battery life.

Ambient Operating Conditions - -22°F to +158°F (-30°C to +70°C).

Humidity - up to 95% (non-condensing).

Typical Operating Range - 300 feet.

Up to four transmitter units may operate on the same frequency while in close proximity (not less than six feet) to each other.

3-8. Time Multiplex Shared (TMS) System Software.

The system software is structured to minimize "on the air" transmission time of any transmitter. This allows for multiple transmitters to share a common frequency. The TMS system is designed so that a transmitter will send a signal for a predetermined ON time, and then will turn OFF. The length of transmitter ON time is referred to as data burst or packet. The packet length is a function of the quantity of data to be

Section 4 –SLTX Transmitter Operation

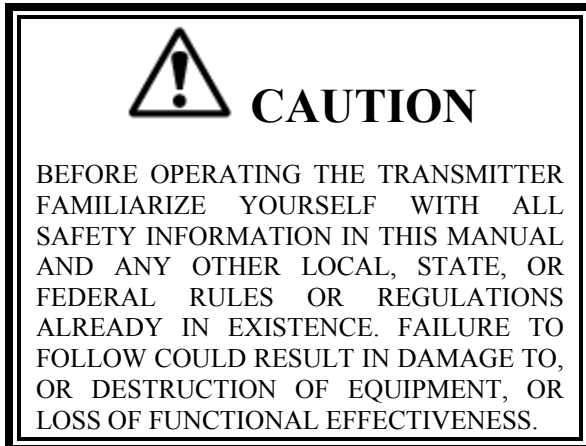

4-1. Power “ON-OFF” Switch (Turns transmitter and receiver ON and OFF).

With the key switch engaged pressing the ON/OFF push-button switch (Part 15) or toggling the ON/OFF toggle switch (Part 90) turns the transmitter and then pushing the START button turns the receiver ON. If the transmitter is ON the BATT MONITOR light is ON or flashing. Pushing the ON/OFF button (Part 15) or resetting the toggle switch to OFF (Part 90) will turn the transmitter and receiver OFF.

4-2. E-STOP (For Emergency Stopping only).

When depressed the MCR relay is opened, the receiver shutdown and power to the equipment is immediately stopped. The transmitter must be turned OFF and ON again to restore normal operation. To be used for emergency stopping only, not for normal system shut down. The E-STOP will not function with the optional key switch turned OFF.

4-3. Motion Push Buttons or Levers.

To activate motor functions, press and hold the push-button or lever that corresponds to the desired motion. To activate higher speed functions for those models so equipped press the motion switch or lever a little farther.

4-4. Battery Monitor LED Indicator.

The battery Monitor LED (red) indicates the transmitter is on, or transmitting, or has a low battery voltage. A slow flash rate indicates the unit is ON. A rapid flash rate indicates a unit is transmitting (when a function or control is

activated). If the battery goes below a safe level the LED will not light, replace battery soon.

4-5. Time-Out-Timer.

Unless this function is disabled the transmitter will turn itself OFF if not used for 15 minutes.

4-6. Key Switch. (For Models So Equipped, disables power to transmitter circuitry only).

For models so equipped, turning the key OFF and removing it will disable the transmitter. Turning the key switch to ON enables power to the transmitter unit, but does not activate the transmitter controls or turn ON the receiver. The ON/OFF push button must be pushed to turn the transmitter and receiver ON or OFF. Under normal procedures it is recommended that the unit be turned OFF with the ON/OFF push button before turning OFF the key switch. On a Part 15 unit, if the key switch is turned OFF with the transmitter and receiver on, the key switch must be turned ON again to use the ON/OFF pushbutton or E-STOP. On a Part 90 system the receiver will turn off with the key switch.

NOTE

THE KEY IS TO BE USED FOR RENDERING THE TRANSMITTER DISABLED ONLY; IT DOES CONTROL THE RECEIVER OR POWER TO OR FROM THE RECEIVER.

Section 4 – SLTX Transmitter Operation (Continued)

4-7. Servicing Information.



CAUTION

FOR PRODUCT MODELS LISTED IN COMPLIANCE WITH UL, CSA AND ANSI INTRINSICALLY SAFE STANDARDS, DO NOT ATTEMPT TO REPAIR WITHOUT USING TELEMOTIVE APPROVED REPLACEMENT PARTS. FAILURE TO DO SO COULD VOID LISTING AND CREATE A SAFETY HAZARD. FOR INTRINSICALLY SAFE PRODUCTS ONLY QUALIFIED TRAINED SERVICE PERSONNEL ARE ALLOWED TO PERFORM REPAIRS. FAILURE TO USE APPROVED SERVICING TECHNIQUES AS WELL AS TELEMOTIVE APPROVED PARTS FOR INTRINSICALLY SAFE PRODUCTS COULD CREATE A SAFETY HAZARD. IF THERE IS ANY QUESTION AS TO WHOM IS QUALIFIED, WHAT PARTS TO USE OR PROPER SERVICE PROCEDURES PLEASE CONTACT YOUR TELEMOTIVE REPRESENTATIVE.



CAUTION

DO NOT ATTEMPT TO OPEN OR SERVICE THE SLTX UNIT. ONLY TRAINED QUALIFIED INDIVIDUALS SHOULD DO SERVICING. STRICT ANTI-STATIC HANDLING PROCEDURES MUST BE FOLLOWED. FAILURE TO FOLLOW THIS CAUTION COULD RESULT IN SERIOUS DAMAGE TO EQUIPMENT AND/OR VOID THE WARRANTY.

Section 5 – SLTX Transmitter Servicing (Continued)

5-1. SLTX Transmitter Board Setup Information.

The SLTX Transmitter Board is shown in Figure 5-1. Refer to paragraphs 5-1 through 5-10 for servicing procedures.

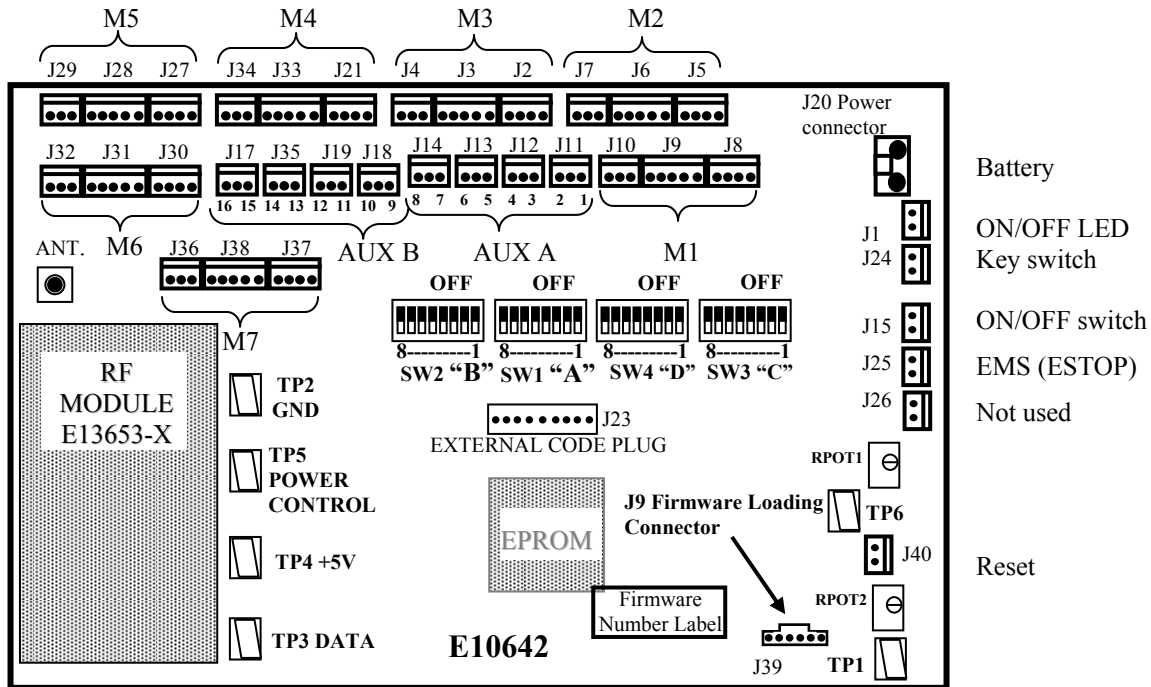

Figure 5-1. 10K AND 18K SLTX Transmitter Board

5-2. SLTX Programming Switches.

The programming switch SW3 controls the following features: *(These only apply to units originally programmed to utilize these features).*

External Code Plug Enable – Switch SW3-position 1 turn “ON” to enable external code plug.

Time-Out-Timer Disable – Switch SW3-position 8 turn “ON” to disable transmitter time-out timer.

5-3. Access Codes Switches. (SW1 and SW2). Setting Access Code (for units with no external code plug only).

For Part 90 systems the 12 bit access code is assigned starting with position A1 through A8

then B1 through B4. For 8 bit access codes switch B is not used.

The access code is set at the factory and should not be changed unless absolutely necessary. If a spare transmitter unit is used, the receiver unit access code should be changed to match the access code of the spare transmitter unit. For Part 15 systems the access codes are printed on a white label on the outside of any transmitter and may be matched to “A” and “B” on the receiver CPU Board without having to open the transmitter housing.

Switch SW2 (B) in the transmitter must match switch (B) on the receiver CPU Board and switch SW1 (A) in the transmitter must match switch (A) on the receiver CPU Board.

If the codes do not match you will get an error light DS9 on the receiver CPU Board while transmitting.

Section 5 – SLTX Transmitter Servicing (Continued)

If you are reprogramming a spare transmitter make sure the other transmitter is securely taken out of service.

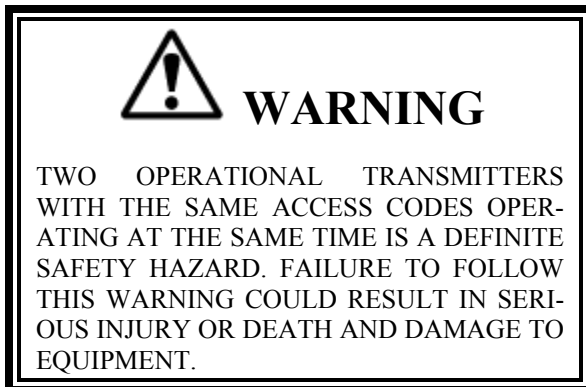

Telemotive receivers are shipped with the access code settings for the transmitter marked on the receiver door.

Also a label on the transmitter lists the access code settings inside. The positions on the transmitter label match the switch settings. The “1” by A1 means the switch position A1 should be “ON” and “0” means A1 should be “OFF”.

5-3.1.1. Changing Transmitter Access Codes.

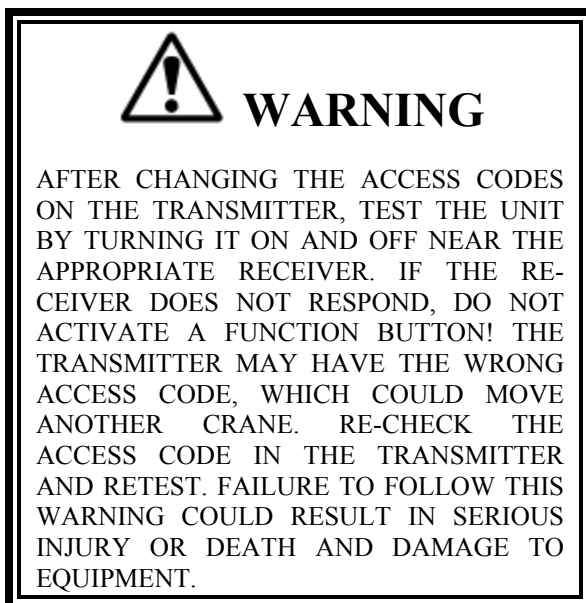

5-3.2. 10K Series SLTX Programming Switches SW3 and SW4 Programming.

5-3.2.1. Transmitter programming SW3.

5-3.2.1.1. Positions 1-7 (Keep turned “OFF”).

5-3.2.1.2. Position 8 Time-out-timer Disable. (Normally keep turned “OFF”).

The transmitter has an approximate 15-minute time-out-timer. If the transmitter is not used for over 15 minutes it will shut down. This transmitter time-out-timer function is transmitter dip switch selectable. SW3 position 8 disables the time-out-timer. Turning SW3-8 “ON” disables the time-out-timer.

5-3.2.2. Transmitter programming SW4.

5-3.2.2.1. Position 1-2 Mode Enable. (Standard Mode 1, keep 1-2 turned “OFF”).

Mode 1, SW4 1-2 all “OFF”. The 10K12 single speed system comes standard configured this way from the factory with three motion controls and six auxiliaries (controlled by the toggle switches). The 10K12 2-speed system comes standard configured this way from the factory with three 2-speed controls and three auxiliaries (controlled by the toggle switches, the rotary is non-functional).

Mode 2, SW4 1 turned “OFF” and SW4 2 turned “ON”. The 10K12 2-speed system configured this way is able to control four 2-speed motion controls and no auxiliaries this give bridge, trolley, main and aux hoist. The rotary selector switch functions are H1 main hoist, H2 aux hoist and B both main and aux hoist (the toggle switches are non-functional).

Mode 3, SW4 1 and 2 turned “ON”. The 10K12 2-speed system will control up to 5 motors using the rotary selector switch. This mode reconfigures two of the 10K12 auxiliary outputs (Aux 1 and Aux 2) to be external motor select functions by the rotary switch. In this mode the auxiliary toggle switch Aux 1 and Aux 2 is disabled. When the rotary switch is in the H1 or H2 position Aux 1 relay or Aux 2 relay will pull in respectively when ever trolley or hoist pushbuttons are pressed. When the rotary switch is in B position both Aux 1 and Aux 2 relays will pull in.

5-3.2.2.2. Position 3 Disable Tandem for Hoist and Trolley. (Normally keep turned “OFF”).

Section 5 – SLTX Transmitter Servicing (Continued)

For cranes with auxiliary hoists and/or trolleys, turning this switch “ON” disables the transmitter selector switch “B” position (both function) that selects tandem operation of hoist or trolley.

5-3.2.2.3. Position 4 Invert Crane Select Aux. Outputs. (Normally keep turned “OFF”).

For cranes that use the select function only, turning this switch “ON” inverts the select function operation so that the relay closes for the **unselected function**.

5-3.2.2.4. Positions 5-7 Extended Crane Control Configurations. (Standard all “OFF” otherwise see the appropriate receiver manual).

The 10K12/18 SLTX transmitter is available with extended crane control configurations. These options are switch configurable on the transmitter. The eight-position dip switches SW3 and SW4 on the transmitter can provide all configurations with a single transmitter CPU EPROM for the 2-speed transmitter. See your receiver manual for available configurations and the switch programming needed to provide them.

5-3.2.2.5. Position 8 No Function (keep turned off).

5-4. To Check Data.

1). For data input use Data pin on RF Module.

2). Use RF SW pin on RF Module for External Trigger input.

3). Use TP2 for Ground.

5-5. Battery Monitor.

Set to 5.8 Volts by R6 and R8 not adjustable.

5-6. Analog Voltage Reference.

Controls lever range, V+ (TP1) factory adjusted with RPOT2 (zero adjust) V- (TP6) factory adjusted with RPOT1 (full scale adjust).

5-7. Transmit LED.

This flashing red LED flashes rapidly during transmit, slowly when unit is ON and turns out when battery is low.

5-8. Batteries and Charger.

Two batteries are available, a disposable alkaline battery BT10KP-0 and a rechargeable NiCad BT10KP-1. The single unit charger for the BT10KP-1 is E10670-1. The typical recharge time for a completely discharged battery is approximately three hours. Please follow local regulations for the disposal of any battery product.

5-9. Replacement Parts.

The following pictures detail replacement parts for the SLTX:

Section 5 – SLTX Transmitter Servicing (Continued)

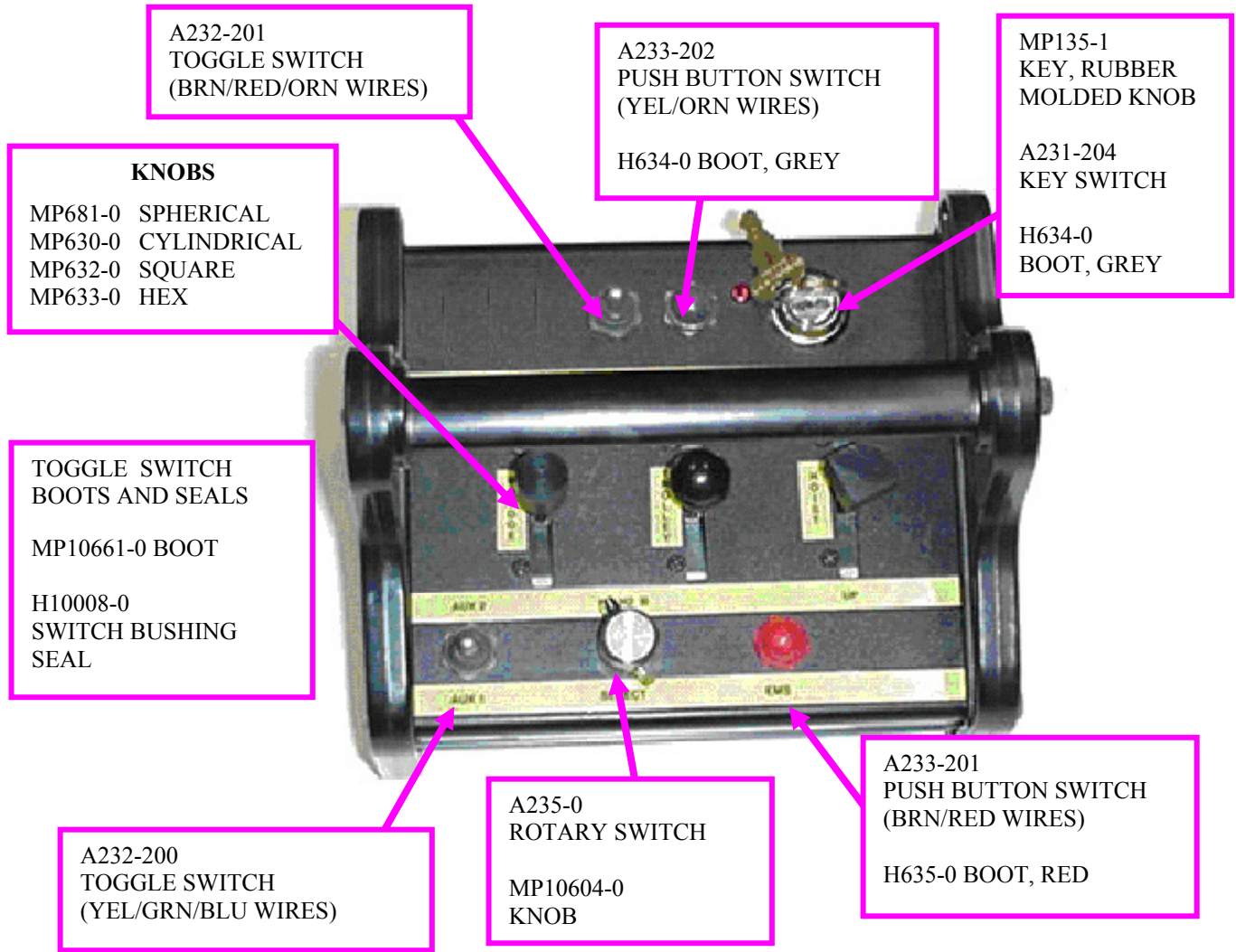

A232-201
TOGGLE SWITCH
(BRN/RED/ORN WIRES)

A233-202
PUSH BUTTON SWITCH
(YEL/ORN WIRES)

H634-0 BOOT, GREY

MP135-1
KEY, RUBBER
MOLDED KNOB

A231-204
KEY SWITCH

H634-0
BOOT, GREY

KNOBS
MP681-0 SPHERICAL
MP630-0 CYLINDRICAL
MP632-0 SQUARE
MP633-0 HEX

TOGGLE SWITCH
BOOTS AND SEALS

MP10661-0 BOOT

H10008-0
SWITCH BUSHING
SEAL

A232-200
TOGGLE SWITCH
(YEL/GRN/BLU WIRES)

A235-0
ROTARY SWITCH

MP10604-0
KNOB

A233-201
PUSH BUTTON SWITCH
(BRN/RED WIRES)

H635-0 BOOT, RED

Section 5 – SLTX Transmitter Servicing (Continued)

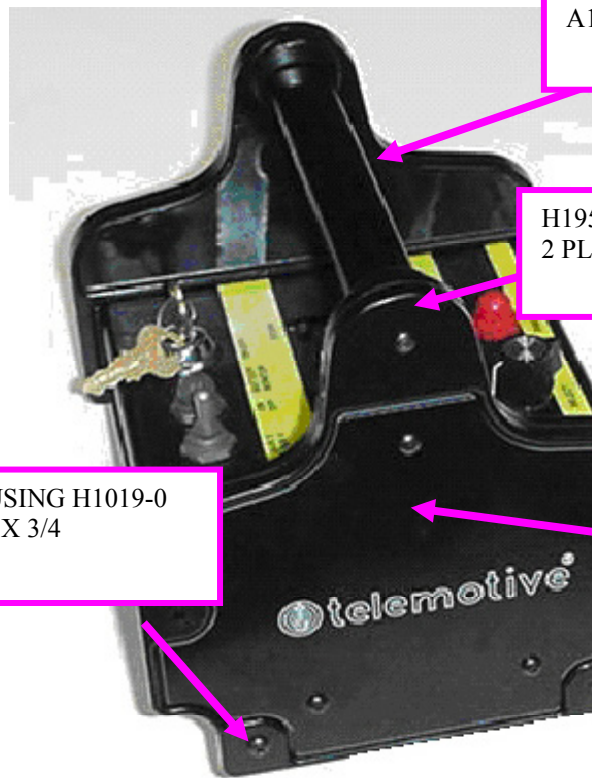

A1444-9 10K METAL HANDLE

H1954-1 SCREW 6-32 X 1 METAL HANDLE
2 PLACES EACH

METAL HOUSING H1019-0
SCREW 6-32 X 3/4
(4 PLACES)

A2261-111
10K END CAP ASSEMBLY
UHF ANTENNA UNLICENSED

A2261-100
18K END CAP ASSEMBLY
VHF ANTENNA LICENSED

A2261-110
18K END CAP ASSEMBLY
UHF ANTENNA LICENSED

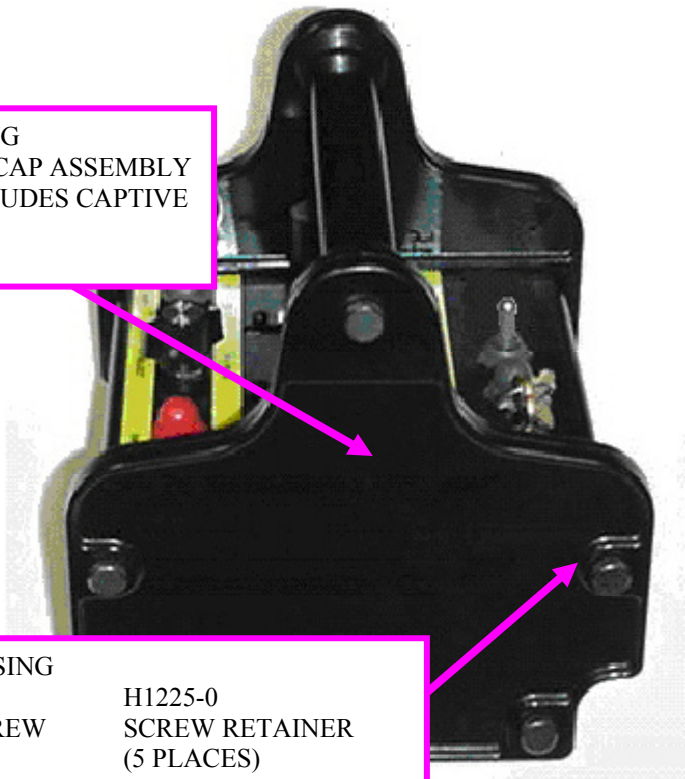

METAL HOUSING
A2260-100 END CAP ASSEMBLY
BATTERY, INCLUDES CAPTIVE
SCREWS

METAL HOUSING
H732-1
CAPTIVE SCREW
(5 PLACES)

H1225-0
SCREW RETAINER
(5 PLACES)

Section 5 – SLTX Transmitter Servicing (Continued)

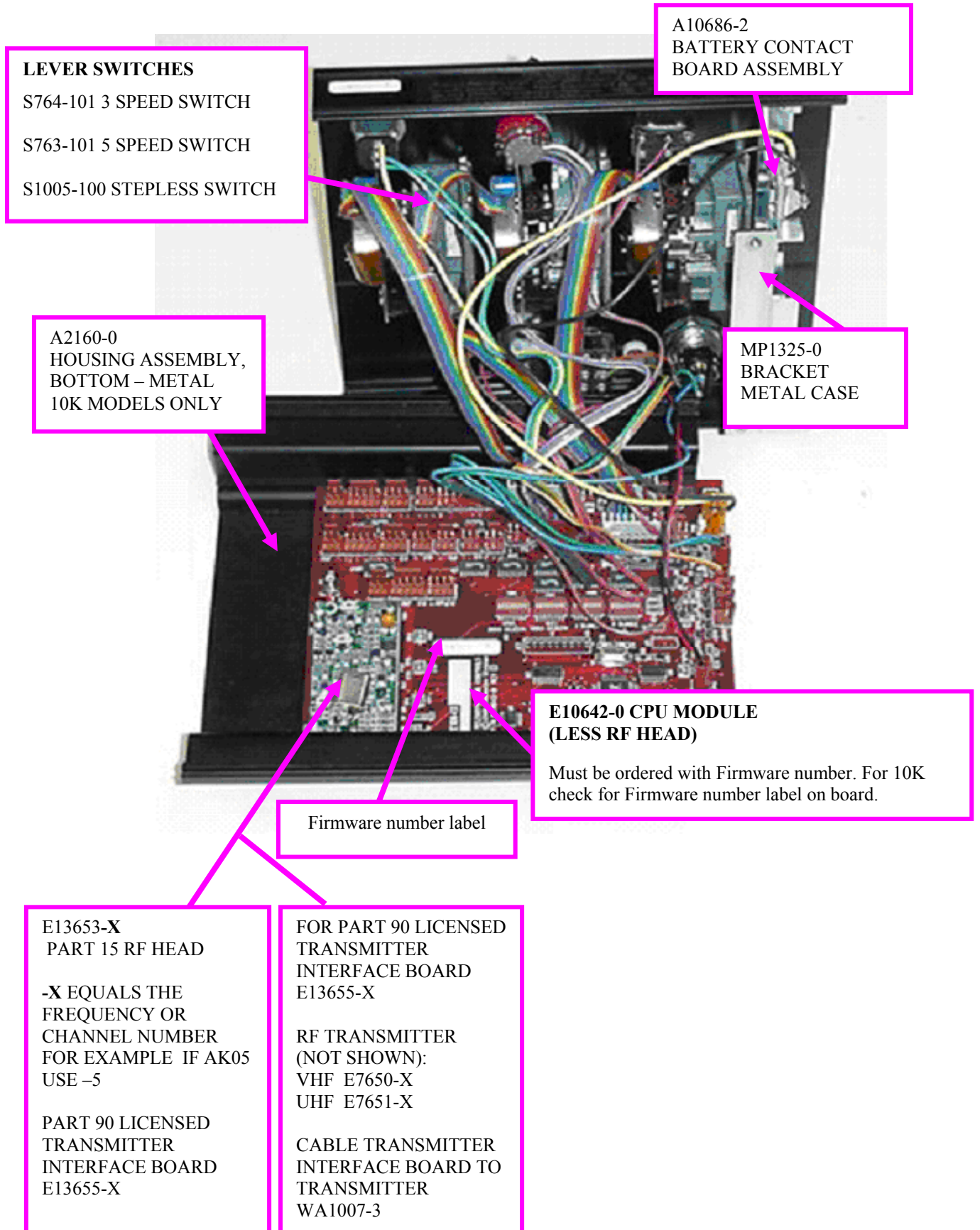

LEVER SWITCHES
 S764-101 3 SPEED SWITCH
 S763-101 5 SPEED SWITCH
 S1005-100 STEPLESS SWITCH

A10686-2
 BATTERY CONTACT
 BOARD ASSEMBLY

A2160-0
 HOUSING ASSEMBLY,
 BOTTOM – METAL
 10K MODELS ONLY

MP1325-0
 BRACKET
 METAL CASE

**E10642-0 CPU MODULE
 (LESS RF HEAD)**
 Must be ordered with Firmware number. For 10K
 check for Firmware number label on board.

Firmware number label

E13653-X
 PART 15 RF HEAD

 -X EQUALS THE
 FREQUENCY OR
 CHANNEL NUMBER
 FOR EXAMPLE IF AK05
 USE -5

 PART 90 LICENSED
 TRANSMITTER
 INTERFACE BOARD
 E13655-X

FOR PART 90 LICENSED
 TRANSMITTER
 INTERFACE BOARD
 E13655-X

 RF TRANSMITTER
 (NOT SHOWN):
 VHF E7650-X
 UHF E7651-X

 CABLE TRANSMITTER
 INTERFACE BOARD TO
 TRANSMITTER
 WA1007-3

Section 5 – SLTX Transmitter Servicing (Continued)

This page intentionally left blank.